

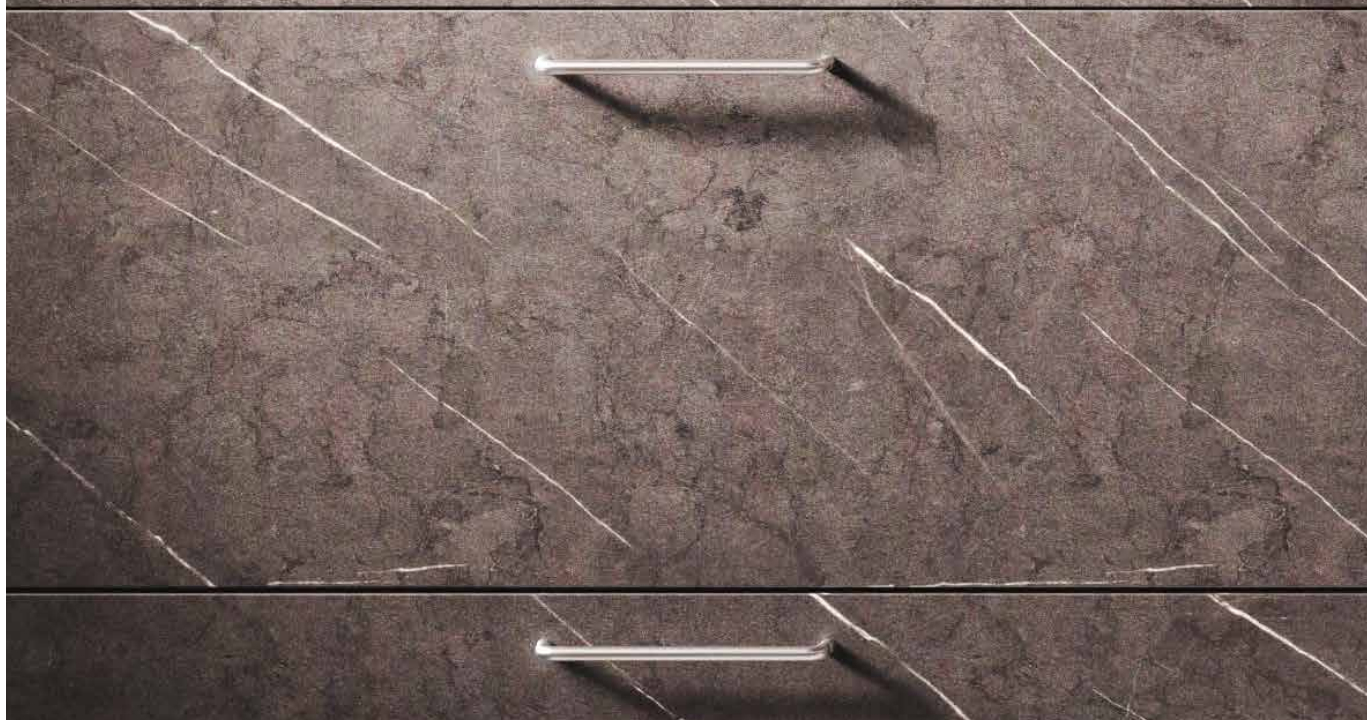

Kitchen Journal

Revista de cocina | Giornale delle cucine | Køkkenbrochure

2021





Philosophy

Multifaceted and inspiring. Discover a kitchen collection that fits your lifestyle perfectly. Come on an exciting journey and experience the most beautiful combinations of design and functionality. Deliberately set highlights give every kitchen its very own character. From a long breakfast with the children to a quick lunch and a big dinner in the evening.



Filosofía

Versátil e inspiradora. Descubra una colección de cocina que se adapta perfectamente a su vida. Acompáñenos en un viaje emocionante y conozca las combinaciones más interesantes de diseño y funcionalidad. La elección meditada de detalles le da un carácter único y personal a cada cocina. Tanto para disfrutar de un largo desayuno con los niños como para un almuerzo rápido o para una gran cena con sobremesa.

Filosofia

Stimolante e dalle mille sfaccettature. Scoprite una gamma di cucine che si adatta perfettamente alla vostra vita. Unitevi con noi in un viaggio emozionante alla scoperta delle più belle combinazioni di design e funzionalità. Note appositamente studiate per dare ad ogni cucina un carattere unico. Dalla colazione prolungata con i bambini ad un pranzo veloce e la sera, una grande cena.

Filosofi

Inspirerende og rig på nuancer. Opdag en køkkenkollektion, der passer perfekt til dit liv. Kom med på en spændende rejse og oplev de skønneste kombinationer af design og funktionalitet. Hvert køkken fået dets eget udtryk og karakter. Fra det stort morgenbord med børnene over den hurtige frokost til den hyggelige middag om aftenen.



Modernity

Modernidad | Modernità | Moderne

8
LOFT
Polar white | Blanco polar | Bianco polare | Polarhvid

14
MERKUR

Carrara white | Carrara blanco | Carrara bianco | Carrara Hvid

LOFT

Graphite | Grafito | Grafite | Grafit

16
LASER SOFT

Aquamarine | Aguamarina | Aquamarina | Havblå

20
STEEL

Metalic light brushed | Metálico cepillado luminoso | Metallo spazzolato chiaro | Lysmetallic børstet

BALI

Summer oak | Roble de verano | Farnia | Sommer Eg

22
COMET

Putty concrete pearl grey
Hormigón enfosc. gris perla
Calcestr. spat. grigio perla
Beton Perlegrå

26
BALI

Summer oak | Roble de verano | Farnia | Sommer Eg

28
LASER BRILLANT

Pearl grey | Gris perla | Grigio perla | Perlegrå

30
LOFT

Graphite | Grafito | Grafite | Grafit

32
LASER BRILLANT

Polar white | Blanco polar | Bianco polare | Polarhvid

34
METEOR

Black steel | Acero negro | Acciaio nero | Sort Stål

LASER SOFT

Black | Negro | Nero | Sort

36
MERKUR

Marble dark
Mármol oscuro
Marmo scuro
Mørk Marmor

TORONTO

Cognac vintage oak
Roble envejecido coñac
Rovere antico cognac
Cognac Vintage Eg

38
NEO

Taupe | Satén | Satin | Satin

Handleless

Sin tiradores | Senza maniglie | Grebssløs

42
MERKUR GL

Carrara white
Carrara blanco
Carrara bianco
Carrara Hvid

LASER SOFT GL

Pearl grey | Gris perla | Grigio perla | Perlegrå

48
STEEL GL

Metalic light brushed
Metálico cepillado luminoso
Metallo spazzolato chiaro
Lysmetallic børstet

LASER SOFT GL

Graphite | Grafito | Grafite | Grafit

52
VANCOUVER GL

Sand vintage oak | Roble envejecido arena | Rovere antico sabbia | Sand Vintage Eg

METEOR GL

Black steel | Acero negro | Acciaio nero | Sort Stål

54
LUNA

White | Blanco | Bianco | Hvid

58
LASER BRILLANT GL

Polar white | Blanco polar | Bianco polare | Polarhvid

TORONTO GL

Black oak | Roble negro | Rovere nero | Sort Eg

59
LASER BRILLANT GL

Polar white | Blanco polar | Bianco polare | Polarhvid

TORONTO GL

Natural vintage oak | Roble envejecido natural | Rovere antico natura | Natural Vintage Eg

60
TORONTO GL

Cognac vintage oak
Roble envejecido coñac
Rovere antico cognac
Cognac Vintage Eg

64
LASER SOFT GL

White | Blanco | Bianco | Hvid

Modern Country

Modern Country | Modern Country | Modern Country

68
MALAGA
Graphite | Grafito | Grafite | Grafit

TORONTO

Cognac vintage oak | Roble envejecido coñac | Rovere antico cognac | Cognac Vintage Eg

72
BRISTOL

Black | Negro | Nero | Sort

74
HAMPTON

Pastel green | Verde pastel | Verde pastello | Pastelgrøn

76
MALAGA
Graphite | Grafito | Grafite | Grafit

78
GRANADA

White | Blanco | Bianco | Hvid

80
BOSTON

Sand oak | Roble arena | Rovere sabbia | Sand Eg

82
BRISTOL

Velvet blue | Azul seda | Blu velluto | Fløjlsblå

86
BREDA
White | Blanco | Bianco | Hvid

88
LOTUS

Pearl grey | Gris perla | Grigio perla | Perlegrå

92
LOTUS

Graphite | Grafito | Grafite | Grafit

Details

Detalles | Dettagli | Detaljer

98
Wall unit SlightLift
Armario alto SlightLift
Pensile SlightLift
SlightLift

99
Glass roller shutter cabinet
Armario con persiana de cristal
Mobile con serrandina in vetro
Jalousiskabet

100
Equipment
Equipamiento
Allestimento
Udstyr

124
Standard carcasses
Armazones estándar
Scocce standard
Standardkorpus – oversigt

125
Front overview
Frentes – Visión de conjunto
Elenco modelli
Fronter – oversigt

130
Worktops
Encimeras
Piani di lavoro
Bordplader

133
Handles
Tiradores
Maniglie
Greb

136
PURemission
PURemission
PURemission
PURemission

137
PUResist
PUResist
PUResist
PUResist

Modernity

Chic & modern. The kitchen styles of the “modern” category are clear, multifaceted and functional. The focus is on clear structures with unconstrained fronts and many colour variations. In the kitchen line “modern” you will discover many beauties that will inspire you from the first moment. Because if you like to cook, you need a kitchen that thinks outside the box and supports you.



Modernidad

Elegante y moderna. Las cocinas de la categoría «Modernidad» se presentan como sencillas, versátiles y funcionales. La atención se centra en estructuras sencillas con frentes despejados y muchas variaciones de color. En las cocinas de esta categoría, puede descubrir muchas maravillas que le fascinarán desde el primer momento. Porque cualquiera que disfrute de la cocina necesita una que le inspire y estimule.

Modernità

Moderna ed elegante. I modelli della sezione "modernità" si distinguono per chiarezza, versatilità e funzionalità. L'attenzione si concentra su strutture chiare e ante leggere dalle molteplici varianti di colore. Nella linea cucina moderna scoprirete molti lati che vi ispireranno fin dal primo momento. Perché se vi piace cucinare, avete bisogno di una cucina che pensi con voi e vi dia supporto.

Moderne

Chic og moderne. Køkkenprogrammet under rubrikken "Moderne" præsenteres inspirerende og funktionelt. Forest fremstår klare strukturer og afslappede fronter i mange farvevariationer. I køkkenlinjen Moderne vil du opleve mange skønheder, som er nemme at forelske sig i. Den der laver mad har brug for et køkken, der er gennemtænkt".

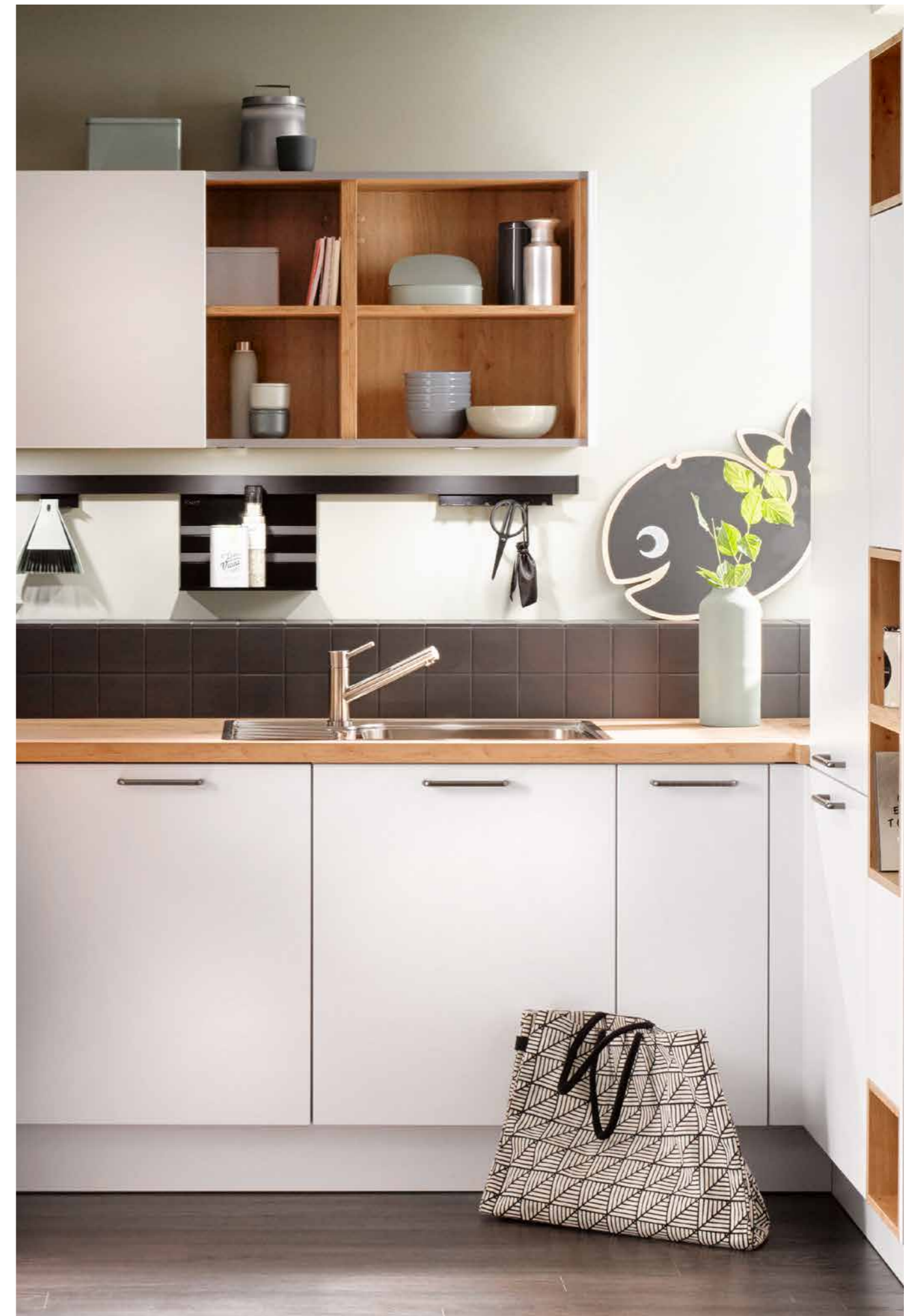



LOFT



Polar white
Blanco polar
Bianco polare
Polarhvid

TOUCHfree
anti finger print

video



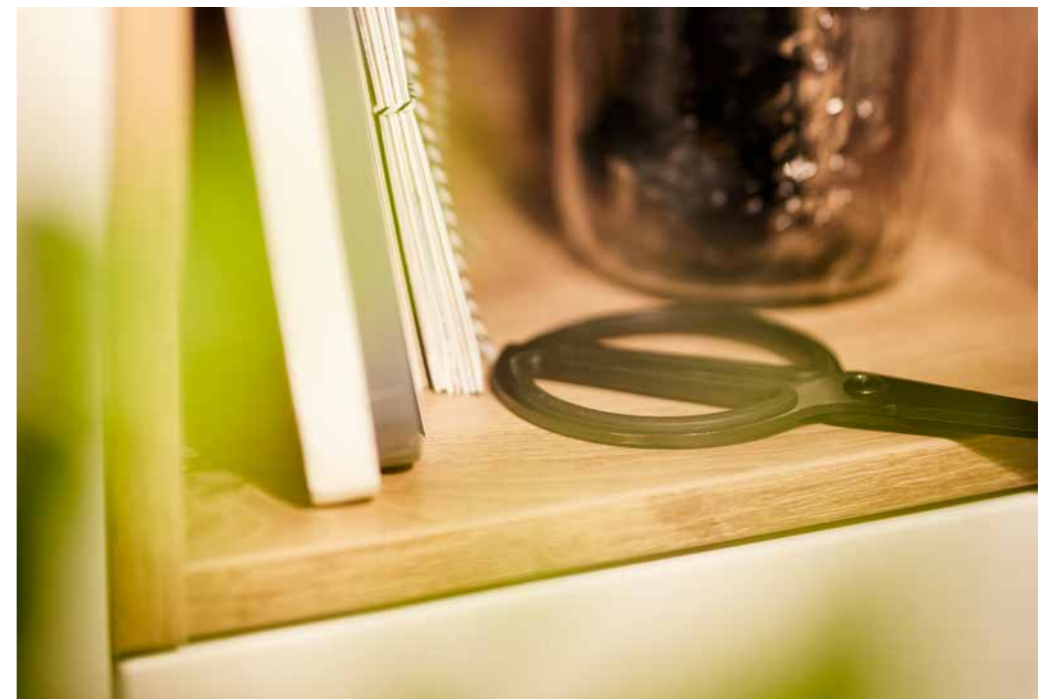





MERKUR

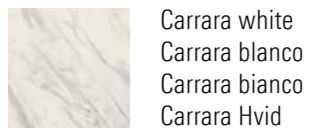

Carrara white
Carrara blanco
Carrara bianco
Carrara Hvid

LOFT



Graphite
Grafito
Grafite
Grafit

TOUCHfree
anti finger print

PerfectSense





LASER SOFT



Aquamarine
Aguamarina
Aquamarina
Havblå







STEEL



Metalic light brushed
 Metálico cepillado luminoso
 Metallo spazzolato chiaro
 Lysmetallic børstet

BALI



Summer oak
 Roble de verano
 Farnia
 Sommer Eg

MAX

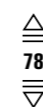

More storage space
 Más espacio de almacenamiento
 Più capienza
 Mere lagerplads

Pleasant working height
 Altura de trabajo comfortable
 Altezza ergonomica gradevole
 Behagelig arbejdshøjde





COMET



Putty concrete pearl grey
Hormigón enfosc. gris perla
Calcestr. spat. grigio perla
Beton Perlegrå





Clever solutions

This way, the space is used efficiently and looks great. Smart solutions create the feeling that everything is always in the right spot. Excellent organisation systems complement the kitchen and can be combined with all fronts. The harmonious interplay of function and design results in a wonderfully pleasant feeling of living.



Soluciones inteligentes

Tenemos diferentes herramientas que le ayudarán a aprovechar el espacio de forma eficiente, además de ofrecerle un diseño increíble. Estas soluciones inteligentes crean la sensación de que todo está siempre bien colocado. Los excelentes sistemas de organización complementan la cocina y pueden combinarse con cualquier tipo de frente. La combinación armoniosa de funcionalidad y diseño crea una maravillosa y agradable sensación de confort.

Soluzioni intelligenti

In questo modo lo spazio viene sfruttato in modo efficiente e si presenta sempre in modo impeccabile. Le soluzioni intelligenti danno la sensazione che tutto sia sempre al suo posto. Gli eccezionali sistemi di organizzazione completano la cucina e possono essere combinati con tutti i modelli. L'armonioso gioco di funzionalità e design crea una sensazione davvero piacevole nel vivere la cucina.

Kloge løsninger

Sådan bliver rummet effektivt udnyttet og ser samtidig godt ud. Smarte løsninger giver følelsen af, at alt altid er på rette plads. Fremragende indretningssystemer fuldender køkkenet og er kombinerbare med alle fronter. I harmonisk sammenspil mellem funktion og design får du en herlig oplevelse af hjem.



BALI



Summer oak
 Roble de verano
 Farnia
 Sommer Eg

MAX

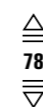

More storage space
 Más espacio de almacenamiento
 Più capienza
 Mere lagerplads

Pleasant working height
 Altura de trabajo comfortable
 Altezza ergonomica gradevole
 Behagelig arbejdshøjde





LASER BRILLANT

■ Pearl grey
■ Gris perla
■ Grigio perla
■ Perlegrå





LOFT

Graphite
 Grafito
 Grafite
 Gravit

TOUCHfree
 anti finger print

MAX

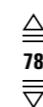

More storage space
 Más espacio de almacenamiento
 Più capienza
 Mere lagerplads

Pleasant working height
 Altura de trabajo comfortable
 Altezza ergonomica gradevole
 Behagelig arbejdsøjde





LASER BRILLANT



Polar white
Blanco polar
Bianco polare
Polarhvid

MAX

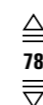

More storage space
Más espacio de almacenamiento
Più capienza
Mere lagerplads

Pleasant working height
Altura de trabajo comfortable
Altezza ergonomica gradevole
Behagelig arbejdshøjde





METEOR



Black steel
Acero negro
Acciaio nero
Sort Stål

LASER SOFT



Black
Negro
Nero
Sort





MERKUR



Marble dark
Mármol oscuro
Marmo scuro
Mørk Marmor

TORONTO



Cognac vintage oak
Roble envejecido coñac
Rovere antico cognac
Cognac Vintage Eg

PerfectSense

MAX

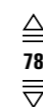

More storage space
Más espacio de almacenamiento
Più capienza
Mere lagerplads

Pleasant working height
Altura de trabajo comfortable
Altezza ergonomica gradevole
Behagelig arbejdhøjde





NEO

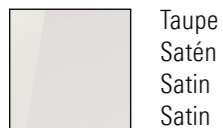

Taupe
Satén
Satin
Satin

MAX

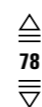

More storage space
Más espacio de almacenamiento
Più capienza
Mere lagerplads

Pleasant working height
Altura de trabajo comfortable
Altezza ergonomica gradevole
Behagelig arbejds højde





Handleless

Puristic and fascinating – the handleless kitchen. Depending on the design, the channel handles are either hidden or specially highlighted with LED lighting. The Sensomatic ensures that pull-outs and drawers slide magically in and out with a simple push. No handle disturbs the charisma of the impressive fronts.



Sin tiradores

Las cocinas sin tiradores le ofrecen un diseño que atraerá todas las miradas. Los frentes planos no tienen pomos ni tiradores. Un diseño totalmente fantástico. Esto hace que la cocina tenga una apariencia uniforme. Puede elegir entre la tecnología Push to Open y Sensomatic: un simple toque con el dedo le permite abrir y cerrar los cajones y gavetas. ¡Un gran invento!

Senza maniglie

Attrante e dalle forme pure: la cucina senza maniglie. A seconda delle esigenze di design, la gola può rimanere un dettaglio piacevolmente discreto o anche essere messa in primo piano grazie all'illuminazione con LED. La tecnologia Sensomatic fa sì che cestoni e cassetti si aprano come per magia con una semplice pressione. E nessuna maniglia interrompe l'elegante scorrere delle superfici.

Grebsløs

Rent og attraktivt – det grebsløse køkken. Grebslisten kan enten være diskret eller sættes ekstra i scene ved hjælp af LED-belysningen. Sensomatic-teknikken sørger for, at udtræk og skuffer nærmest magisk åbner sig ved et enkelt tryk. Her forstyrres intet greb udseendet af fronten.



MERKUR GL

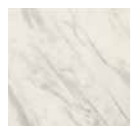

Carrara white
Carrara blanco
Carrara bianco
Carrara Hvid

LASER SOFT GL



Pearl grey
Gris perla
Grigio perla
Perlegrå

PerfectSense

video



SlightLift





SlightLift

A wonderful cabinet shelf system combined with fascinating lighting. A new opportunity every day. It even won the Red Dot Design Award for this. Just awesome.



Un maravilloso sistema de armario y estante combinado con una iluminación fascinante. De esta forma, usted tiene un sinfín de posibilidades de almacenamiento cada día. Este sistema recibió el premio de diseño Red Dot. ¡Simplemente genial!

Una meravigliosa combinazione di pensile e scaffale, arricchita con un effetto luce affascinante. Ogni giorno una nuova personalità. Premiata anche con il Red Dot Design Award. Semplicemente geniale.

Et fantastisk overskabsarrangement kombineret med fascinerende belysningsløsning. Hver dag giver nye muligheder. Derfor fik denne løsning en Red Dot Design Award. Bare genial.



STEEL GL



Metalic light brushed
 Metálico cepillado luminoso
 Metallo spazzolato chiaro
 Lysmetallic børstet

LASER SOFT GL



Graphite
 Grafito
 Grafite
 Grafit







VANCOUVER GL

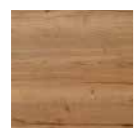

Sand vintage oak
 Roble envejecido arena
 Rovere antico sabbia
 Sand Vintage Eg

METEOR GL



Black steel
 Acero negro
 Acciaio nero
 Sort Stål





LUNA

White
Blanco
Bianco
Hvid

TOUCHfree
anti finger print



Everything fits together

Kitchen cabinets, worktops and shelves in perfect harmony. Because you can of course get shelf elements to match the front and / or worktop. Everything seems like it is made of one piece and looks great.



Combinación perfecta

Armarios de cocina, encimeras y estantes en perfecta armonía. Porque, por supuesto, sus estantes irán a juego con el frente y/o la encimera. Esto proporciona una apariencia uniforme y elegante.

Qui tutto è in armonia

Armadietti, piani di lavoro e scaffali, tutti in perfetta armonia. Infatti i vostri scaffali e i relativi componenti sono sempre abbinati alle ante e/o al top. Questo fa sembrare tutto come se fosse generato dalla stessa matrice e l'effetto è davvero fantastico.

Her passer alt sammen

Køkkenskabe, bordplader og reoler i perfekt harmoni. Så du modtager dine reoler, der selvfølgelig passer til fronterne og/eller bordplade. Så virker alt som en enhed og ser stilfuldt ud.





LASER BRILLANT GL



Polar white
Blanco polar
Bianco polare
Polarhvid

TORONTO GL



Black oak
Roble negro
Rovere nero
Sort Eg



TORONTO GL



Natural vintage oak
Roble envejecido natura
Rovere antico naturale
Natural Vintage Eg





TORONTO GL



Cognac vintage oak
Roble envejecido coñac
Rovere antico cognac
Cognac Vintage Eg





Fascinating corner solutions

“May I introduce myself? My name is Qanto. I store your kitchen appliances quickly and safely in the corner cabinet at the push of a button.” With the Qanto you gain storage space and give your high-quality devices an excellent home. Whether it is a food processor, toaster or coffee bar – this is how you can use the corner cabinet in a truly imaginative way.



Soluciones fascinantes para las esquinas

«Hola, mi nombre es Qanto. Puedo guardar sus utensilios de cocina de forma segura y rápida en el armario de la esquina con sólo pulsar un botón». Con Qanto, puede aprovechar todo el espacio de almacenamiento disponible y, además, le permite guardar sus utensilios de alta calidad en un lugar perfecto. Los armarios esquineros ofrecen multitud de posibilidades de almacenamiento totalmente imaginativas: tanto para almacenar un robot de cocina o una tostadora como para crear un moderno rincón de café.

Affascinanti soluzioni angolari

“Piacere, il mio nome è Qanto. Posso tenere al sicuro nell’angoliera i vostri piccoli elettrodomestici con la semplice pressione di un pulsante”. Con Qanto si guadagna spazio e si dà agli elettrodomestici di alta qualità una casa di tutto rispetto. Che si tratti di un robot da cucina, di un tostapane o di una macchinina da caffè: è così che si usa l’angoliera in modo intelligente e fantasioso.

Fascinerende hjørneløsning

Undskyld mig, mit navn er Qanto. Deres køkkenudstyr opbevarer jeg ved et enkelt tryk på knappen hurtigt og sikkert i hjørneskabet. Med Qanto opnås der ekstra opbevaringsplads og giver dine køkkenmaskiner et fremragende hjem. Uanset om det er til foodprocessoren, brødristeren eller kaffemaskinen – så kommer denne hjørneløsning virkelig til sin ret.



LASER SOFT GL

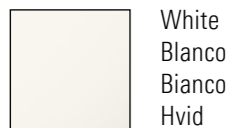

White
Blanco
Bianco
Hvid



Modern Country

Attractive country house style look also for the city. The Modern Country kitchens are taking you to the countryside. Discover an enchanting country house style that gives warmth and security. High-quality materials and loving details such as lattice windows, ornate cornices, shelves with utensil boxes or profiled pilasters reflect the comfort of country life. This creates a favourite place for the whole family.



Modern Country

Un estilo interesante de casa de campo para la ciudad. Las cocinas de la categoría «Modern Country» le transportarán al campo. Descubra un estilo acogedor de casa de campo que da sensación de calidez y hogar. Los materiales de alta calidad y los detalles especiales como las ventanas con travesaños, las molduras de corona decorativas, los estantes con cajones o las columnas de perfil reflejan la comodidad de la vida en el campo. Esto hará que su cocina se convierta en el lugar favorito de toda la familia.

Modern Country

Stile classico attraente anche per la città. La linea Modern Country vi porta in una romantica atmosfera di campagna tutta da scoprire, piena di calore e sensazione di sicurezza. I materiali di alta qualità e i dettagli amorevoli come le vetrinette, i profili decorati delle cornici, i ripiani con i cassettini o le colonne profilate riflettono l'intimità della vita di campagna. Così si crea il posto preferito per tutta la famiglia.

Modern Country

Attraktiv landligt design – også til byen. Modern Country giver en bemærkelsesværdig Landhusstil med varme og grundighed. Høj kvalitet og elskelige detaljer som sprossevinduer, kantprofiler og hylder giver den behagelige oplevelse af at bo på landet. Dette er med til at skabe yndlingsstedet for hele familien.





MALAGA

 Graphite
 Grafito
 Grafite
 Grafit

TORONTO

 Cognac vintage oak
 Roble envejecido coñac
 Rovere antico cognac
 Cognac Vintage Eg







BRISTOL



Black
Negro
Nero
Sort





HAMPTON



Pastel green
Verde pastel
Verde pastello
Pastelgrøn





MALAGA

Graphite
Grafito
Grafite
Grafit





GRANADA



White
Blanco
Bianco
Hvid





BOSTON



Sand oak
Roble arena
Rovere sabbia
Sand Eg





BRISTOL



Samtblau
Azul seda
Blu velluto
Fløjsblå







BREDA



White
Blanco
Bianco
Hvid





LOTUS

Pearl grey
Gris perla
Grigio perla
Perlegrà





Multifaceted shelf module system

Easily connect kitchen, living and work furniture with one another. Create a smart home office or a tasteful coffee bar. Lots of space combined with clever details make the shelf module system a multifunctional favourite place. Whether laptop or coffee machine – just use it as you like.



Estantes temáticos versátiles

Combine fácilmente los muebles de la cocina, los del salón y los de la oficina. Diseñe un espacio de trabajo elegante para casa o un rincón de café con encanto. La combinación de espacio amplio con detalles ingeniosos hace que los estantes temáticos sean unos de los elementos versátiles favoritos de nuestros clientes. Ya sea para colocar el portátil o una cafetera: úselo como quiera.

Scaffali ricchi di inventiva

Come collegare facilmente tra loro la cucina, il soggiorno e lo spazio lavoro. Organizzate in modo efficiente uno spazio per lo smart working o anche un raffinato bar. Tanto spazio combinato con soluzioni intelligenti fanno della scaffale a tema uno degli elementi multifunzione più amati. Che sia il computer portatile o la macchina per il caffè, ecco dove usarli, a proprio piacimento e con fantasia.

Multimøbel

Kombiner let køkken-, bolig- og arbejdsmøbel med hinanden. Indret en smart hjemmearbejdsplads eller en smagfuld kaffebar. Masser af plads kombineret med smarte detaljer gør også multimøblet til et yndlingssted. Uanset om det er til laptop eller kaffemaskine, kan du bruge det, som du vil.



LOTUS

Graphite
Grafito
Grafite
Grafit





Details

Your new dream kitchen consists of many well thought-out details. From the damped hinge to smart organisation systems – from the clever corner solution to the impressive lighting concept. Experience fantastic kitchen elements that make your life much more pleasant. Quality and precision in every detail. In order for you to enjoy your kitchen as long as possible, we test the components for you in a test laboratory.



Detalles

La cocina de sus sueños está compuesta por muchos detalles que deben estar bien meditados. Desde bisagras de cierre suave hasta sistemas de organización inteligentes, tanto soluciones inteligentes para las esquinas como conceptos de iluminación impresionantes. Descubra elementos fantásticos para su cocina que le facilitarán el día a día. Calidad y precisión en cada detalle. Para que pueda disfrutar de su cocina durante mucho tiempo, comprobamos todos los componentes en un laboratorio de pruebas.

Dettagli

La nuova cucina dei vostri sogni è piena di molti dettagli ben studiati. Dalle cerniere a chiusura rallentata ai sistemi di organizzazione intelligenti, dalle soluzioni angolari intelligenti ai sistemi di illuminazione di grande effetto. Provate i fantastici elementi che rendono la vostra vita in cucina molto più piacevole. Qualità e precisione in ogni dettaglio. Per farvi godere della vostra cucina negli anni testiamo per voi tutti gli elementi ed i materiali in un laboratorio altamente specializzato.

Detaljer

Dit nye drømmekøkken består af mange gennemtænkte detaljer. Fra dæmpede hængsler til smarte organisationssystemer – fra den kloge hjørneløsning til et udtryksfuldt belysningskoncept. Oplev de fantastiske køkkenelementer, der vil gøre din tilværelse mere behagelig. Kvalitet i hver en detalje. Vi tester alt materiale på vores laboratorium, så du kan have glæde af dit køkken i mange, mange år.

STANDARD / ART / MAX

As diverse life is,
as multifaceted our kitchens are.

Choose the perfect working height, excellent opening systems
and extraordinary front variations.

Tan diversa como la vida,
son también nuestras cocinas.

Elija alturas de trabajo cómodas, excelentes sistemas
de apertura y variaciones frontales excepcionales.

Così varia com'è la vita,
così versatili sono le nostre cucine.

Scegliete le comode altezze ergonomiche, gli eccezionali sistemi
di apertura e la grandissima varietà di ante.

Vores køkkener er lige så forskellige,
som vores liv er i dag.

Vælg behagelige arbejds højder, fremragende åbningssystemer
og usædvanlige frontvariationer.

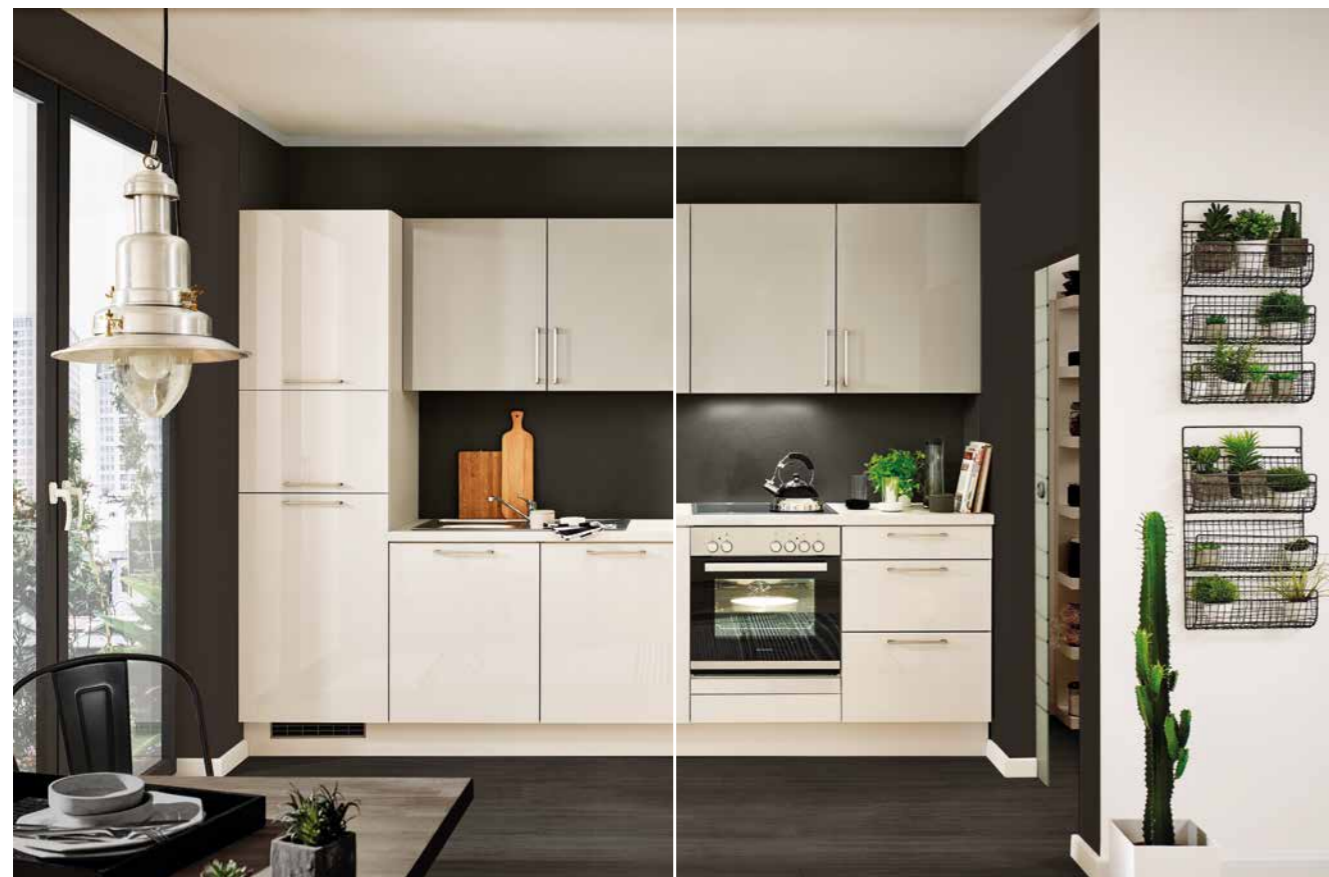

Standard height
Altura estándar
Altezza standard
Højden Standard

MAX height
Altura MAX
Altezza MAX
Højden MAX

STANDARD

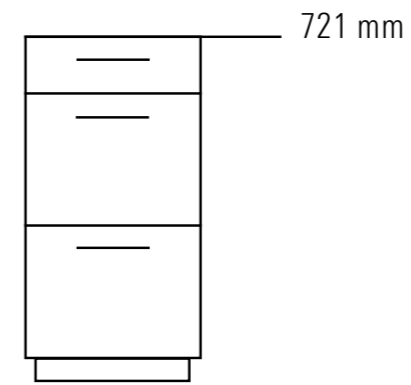

Standard height

Our kitchens in standard heights
are the perfect combination of a
fresh, modern design and great
functionality. The classic version
with it's 721 mm carcass has been
very popular over the past years.

Altura estándar

Las cocinas a altura estándar son
una combinación entre Diseño
moderno y gran funcionalidad.
La versión clásica con 721 mm de
altura del cuerpo se ha extendido
en muchos probado a lo largo de
los años.

Altezza standard

Le cucine con altezza standard
sono la più bella combinazione di
design giovane e grande funzionali-
tà. La variante classica delle basi
alte 721 mm continua a riscuotere
successo negli anni.

Højden Standard

Køkkener i standardhøjde er den
smukkeste kombination af friskt
design og overlegen funktionali-
tet. Den klassiske variant med en
basishøjde på 721 mm har vist sit
værd igennem mange år.

MAX

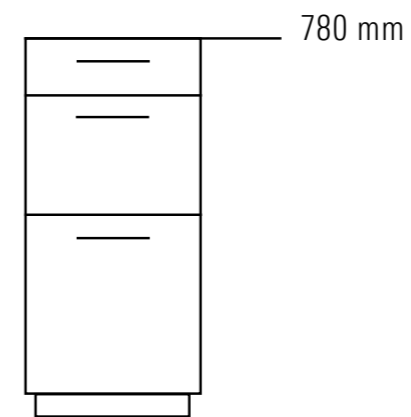

MAX height

With a carcass height of 780 mm
MAX offers the perfect conditions
for tall people. Back-friendly,
attractive and a lot of additional
storage space.

Altura MAX

MAX ofrece con una altura corporal
de condiciones ideales de 780 mm
para grandes personas. Ergonomía,
atractivo y con de espacio adicio-
nal, elofrece la altura MAX.

Altezza MAX

Con le basi alte 780 mm MAX crea
le condizioni ideali per soddisfare
le persone di alta statura. Senza
che la schiena si affatichi, ma con
grande attenzione all'estetica e con
tanta capienza in più.

Højden MAX

MAX har en basishøjde på 780 mm
og er ideelt til høje mennesker.
Højden MAX er god mod ryggen,
attraktiv og har masser af ekstra
plads.

ART

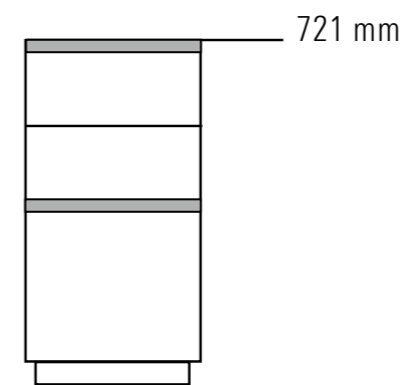

ART Height

Handleless kitchens are very trendy
in modern kitchen designs. Genius
fronts and a modern look in the po-
pular 721 mm height. ART kitchens
are very appealing.

Altura ART

Las cocinas sin tiradores son una
tendencia en diseño de cocina
moderna. Ingenioso Frentes y un
aspecto moderno en la popular
altura de 721 mm hacer que la
cocina ART especial Adorable.

Altezza ART

Le cucine con la gola sono sempre
di tendenza nel design delle cucine
moderne. La geniale combinazione
di ante e look moderno della sempre
attuale altezza 721 mm fanno della
ART una cucina particolarmente
apprezzata.

Højden ART

Grebsløse køkkener er en trend
inden for moderne køkkendesign.
Fantastiske fronter og et moderne
look i den populære højde på 721
mm gør ART-køkkenet særligt
attraktivt.

SlightLift

↑ slide ↖ lift ☀ lights on



reddot award 2018
honourable mention



SlightLift: When exceptional looks meet innovative technology

The SlightLift wall unit impresses with its unusual appearance in combination with atmospheric lighting technology. Whether it is used as a closed wall unit or open as a decorative shelf: it is always an eye-catcher.

The lower front with its handle strip can be slid vertically behind the upper one. Here the integrated lighting control unit can vary the lighting scenario between pleasing ambient lighting and functional light. The word creation SlightLift is a combination of the words „Slide“, „Light“ and „Lift“ and describes the essential wall unit features: sliders, flaps and intelligent lighting control.

SlightLift is distinguished both with the „Iconic Award 2018: Innovative Interior“ as well as the internationally-recognised quality and design award „Red Dot Award 2018 Honourable Mention“.

El SlightLift: un acabado único se da cita con la tecnología más puntera

El armario suspendido SlightLift convence con un diseño único que se aúna con una técnica de iluminación lograda. Ya sea de forma cerrada como armario suspendido o abierto como estantería decorativa: en cualquier de los casos llamará la atención.

El frente inferior con listón para agarrar se puede deslizar, de forma vertical, hacia detrás de la parte superior. Mientras que la unidad de control de la iluminación integrada cambia la iluminación de un nivel más suave y ambientado a una iluminación funcional y viceversa.

El nombre SlightLift se compone de los términos ingleses «Slide», «Light» y «Lift» que describen las características principales de este mueble: deslizable, abatible y con un control de iluminación inteligente.

El SlightLift ha sido galardonado tanto con el premio a la innovación «Iconic Award 2018: Innovative Interior» como con el distintivo de calidad y diseño de renombre internacional «Red Dot Award 2018 Honourable Mention».

SlightLift: innovazione tecnologica ed estetica, mano nella mano

Il pensile SlightLift, con la sua straordinaria estetica unita a suggestivi effetti di luce offre tanti argomenti per farsi scegliere: come pensile chiuso o elemento a giorno come oggetto d'arredo, sa catturare sempre lo sguardo di tutti.

L'anta inferiore, dotata di un sottile profilo come maniglia, scorre dolcemente in verticale dietro all'anta superiore. La luce integrata può essere regolata in modo da cambiare l'atmosfera dell'ambiente da confortevole a funzionale. Il nome d'arte SlightLift è una combinazione delle parole „Slide“, „Light“ e „Lift“ che sintetizzano le sue caratteristiche essenziali: movimento, chiusura e controllo intelligente della luce.

SlightLift ha ottenuto il premio per l'innovazione „Iconic Award 2018: Innovative Interior“ e il riconoscimento a livello mondiale „Red Dot Award 2018 Honourable Mention“ per la qualità ed il design.

SlightLift: Når unik optik møder innovativ teknik

SlightLift overskabet imponerer med en usædvanlig optik i kombination med en stemningsfyldt lysteknik. Uanset om lukket som overskab eller åben som en dekorativ reol: I alle tilfælde vækker det opmærksomhed.

Den nederste læge med grebsliste kan skubbes lodret ind bag den øverste læge. Samtidig skifter den integrerede lysstyringsenhed lys-scenariet fra en behagelig hyggebelysning til funktionslys og tilbage igen.

Kunstnavnet SlightLift er sammensat af ordene „Slide“, „Light“ og „Lift“ og dækker skabets væsentligste egenskaber: Skubbe, vippe og den intelligente lysstyring.

SlightLift vandt både innovationsprisen „Iconic Award 2018: Innovative Interior“ og den internationalt anerkendte kvalitets- og designpris „Red Dot Award 2018 Honourable Mention“.

GLASS ROLLER SHUTTER CABINET

ARMADI CON SERRANDINA IN VETRO



Elegant look and excellent characteristics: the glass roller shutter cabinet has an impressive design and functionality.

Whether as a wall unit or a worktop wall unit, the glass roller shutter will be an eye-catcher in every modern kitchen.

The model, with an electrified glass shutter, ensures quiet opening and closing using the invisible touch switch on the lower lamella.

The manual version will impress with its integrated stainless-steel brushed handle and the ball-bearing cable guide roller ensures smooth and stable running.

The integrated glass cover creates a harmonious and high-quality overall appearance.

For an attractive appearance in the closed state as well as in open-look shelving.

Aspecto elegante y características de funcionamiento excelentes: el armario con persiana de cristal convence por su diseño y su función

Bien como armario superior o como sobreencimera: el armario con persiana de cristal es un auténtico atractivo en una cocina moderna en cualquiera de sus versiones.

La versión con persiana de cristal eléctrica garantiza una apertura y un cierre con sonido afectivo y silenciosos por medio del interruptor táctil invisible en la laminilla inferior. La variante manual seduce con su tirador integrado de color acero cepillado y, gracias a las guías de cable con rodamientos de bolas, garantiza una marcha suave y estable. El frente de cristal integrado, crea una apariencia general armoniosa y de gran calidad. Para disfrutar de un aspecto atractivo tanto en su discreta imagen cerrada como también con la óptica de estantería al abrirlo.

ARMARIO CON PERSIANA DE CRISTAL

GLAS RULLEJALOUSISKAB



Eleganza ed eccezionale scorrevolezza: la serrandina in vetro conquista per design e funzionalità

Come pensile o sopra-lavabo, la serrandina in vetro è il richiamo visivo per eccellenza in qualsiasi cucina moderna.

La versione elettrificata garantisce un'apertura e una chiusura della serrandina in vetro silenziosa ed emozionante grazie all'interruttore a sensore invisibile sulla lamella inferiore.

La variante manuale conquista per il design minimalista della maniglia acciaio inox spazzolato ed allo scorrimento silenzioso e sicuro del meccanismo con cuscinetti a sfera.

La superficie in vetro crea un aspetto complessivo armonioso e di qualità. La sua estetica è sempre attraente, sia a serrandina chiusa, trasparente, sia a serrandina aperta, come scaffale a giorno.

Elegant optik og fremragende funktionskarakteristik: Glasjalousiskabet imponerer med sit design og sin funktion

Både som væg- og overskab: Glasjalousiskabet er uanset udførelse altid et blikfang i det moderne køkken.

Udførelsen med elektrificeret glasjalousi garanterer støjsvag åbning og lukning med den skjulte touch-kontakt på nederste lamel. Den manuelle udgave imponerer med den integrerede grebsliste i børstet rustfrit stål og giver takket være Quadro styring en rolig og stabil løbskarakteristik. Det integrerede glaspanel skaber et overordnet harmonisk udseende i en høj kvalitet.

Har et elegant udtryk både i den clean-lukkede udgave og i den åbne reoloptik.



Base unit with pull-outs behind door.

With surcharge: anti-slip mat.

Armario bajo con gavetas interiores detrás la puerta.

Con recargo: esterilla antideslizante.

Base con cestoni interni dietro l'anta.

Con sovrapprezzo: tappetino antiscivolo.

Underskab med indvendige udtræk bag en låge

Antiskridmätte mod en mindre merpris.

At product range ARThandleless, the bottom shelf has a cross-bonded moulding for opening the wall unit.

Para abrir los armarios altos de la serie sin tiradores (ART), el fondo del armario cuenta con un listón de perfil encolado.

Per l'apertura dei pensili ARTgola il fondo è dotato di un profilo fissato sul bordo frontale.

Bunden forsynes med en pålimet profilliste til at åbne overskabene ved grebsløsART med

ARThandleless – Light profile for channel handle

At the handleless ART line, the carcass sides are already prepared for installation. The channel handles are available in brushed stainless steel, matt white, matt black, matt graphite or matt polar white. Front gable ends can optionally be added at the end of the row.

ART sin tirador – Perfil de gola iluminada

En el acabado «ART sin tirador», los laterales del cuerpo están fresados listos para su montaje. Las molduras están disponibles en los colores acero inoxidable, blanco mate, negro mate, grafito mate y blanco polar mate. En la terminación de la línea hay la posibilidad de planificar los costados con terminación frontal.

ARTgola – Profilo luminoso per la gola

Nella cucina con la gola i lati della scocca vengono fresati per essere predisposti per l'installazione dei profili della gola, disponibile in color acciaio inox, bianco opaco, nero opaco, grafite opaco e bianco polare opaco. Lateralmente è possibile inserire fianchi di chiusura con gola riportata.

GrebsløsART – Belysningsprofil med kelleste

Ved grebsløsART bliver korpussiderne fræset monteringsklare ud, og kellesterne kan leveres i farverne børstet stål, hvid mat, sort mat, grafit mat og polarhvid. Korpusafslutningen kan leveres med vanger på fronten.

Finishes | Acabados | Esecuzioni | Udførelse

352

Matt polar white
Blanco polar mate
Bianco polare opaco
Polarhvid mat

305

Matt white
Blanco mate
Bianco opaco
Hvid mat

320

Stainless steel coloured brushed
Colores acero inoxidable
Color acciaio inox.
Rustfritstål farvet

376

Matt graphite
Grafito mate
Grafite opaco
Grafit mat

355

Matt black
Negro mate
Nero opaco
Sort mat

363

Satin matt
Satin mate
Satin opaco
Satin mat





Pull-out with square railing or glass sides
Gaveta con barandilla rectangular o costados de cristal
Estraibile con corrimano rettangolare oppure lati in vetro
Skuffe med rektangulær ræling eller glassider

Pull-outs

The drawer systems are beautifully shaped, robust and powder-coated in a champagne shade. A wiping channel inside makes them particularly easy to maintain. The system runs on full drawer guide rails with soft closing. The drawer is equipped with a square rail as standard. The side frame can be equipped with glass sides against a small surcharge.

Gavetas

Los sistemas de gavetas son elegantes, estables y están recubiertos con pintura electroestática de un tono champán. Además, son muy fáciles de limpiar gracias a sus cantos redondeados del interior. El sistema funciona sobre rieles de guía totalmente extraíbles con mecanismo de cierre suave automático. La gaveta cuenta con una varilla cuadrada de serie. Por un pequeño suplemento, el bastidor lateral puede equiparse con un cristal.

Cestoni

Il cestoni sono eleganti, stabili e verniciati a polvere in color champagne. Sono inoltre di facile manutenzione grazie alle sponde interne a filo. Il sistema funziona con guide a estrazione totale e rientro ammortizzato. Il cestone è dotato di ringhierina laterale squadrata di serie. Con un piccolo supplemento la sponda laterale può essere in vetro.

Udtræk

Skuffesystemerne er elegante, robuste og pulverlakerede i farven Champagne. Særligt rengøringsvenlige med afrundede hjørner indvendig. Systemet kører på fuldudtræksstyreskiner med SoftClose. Skuffen er som standard forsynet med en rektangulær ræling. Mod en mindre merpris kan skuffen forsynes med sidesarg i glas.



Innovative storage space concepts

Whether base units with solid wood inside organisation system and cutlery trays or integrated, additional drawers – innovative storage space concepts simplify your work and alleviate organisation.

Los innovadores conceptos de espacio

Ya sean las gavetas de madera maciza con organización interior, o los portacubiertos, o los cajones adicionales integrados. Los innovadores conceptos de espacio de almacenaje facilitan el trabajo y consiguen el orden.

L'organizzazione dello spazio

Che i cassetti siano dotati di organizzatori in legno massello o di inserti per posate e contenitori supplementari integrati, l'organizzazione degli interni semplifica la vita e crea ordine.

Innovative opbevaringskoncepter

Uanset om det drejer sig om fuldudtræk med indretning af massivt træ og bestikindsatser eller integrerede ekstra sokkelskuffer – de innovative opbevaringskoncepter gør arbejdet i køkkenet nemmere og skaber hurtigt orden og overblik.



Plinth drawer - 50 - 60 cm wide
 Cajón de zócalo - 50 - 60 cm de ancho
 Cassetto per zoccolo - 50 - 60 cm di larghezza
 Base skuffe - 50 - 60 cm bredde



Vario tray for pull-outs
 Bandeja variable para gavetas
 Inserto Vario per cestoni
 Vario-indsats til udtræk



Cutlery tray solid wood
 Cubertero madera maciza
 Portaposate legno massello
 Bestikindsats massiv bøg



Dark ashgrey
 Fresno gris oscuro
 Frassino grigio scuro
 Ask mørkegrå



Cutlery tray laminate
 Cubertero material sintético
 Portaposate in plastica
 Bestikindsats plast



Cutlery tray laminate translucent
 Cubertero material sintético transparente
 Portaposate in plastica traslucida
 Bestikindsats plast translucent

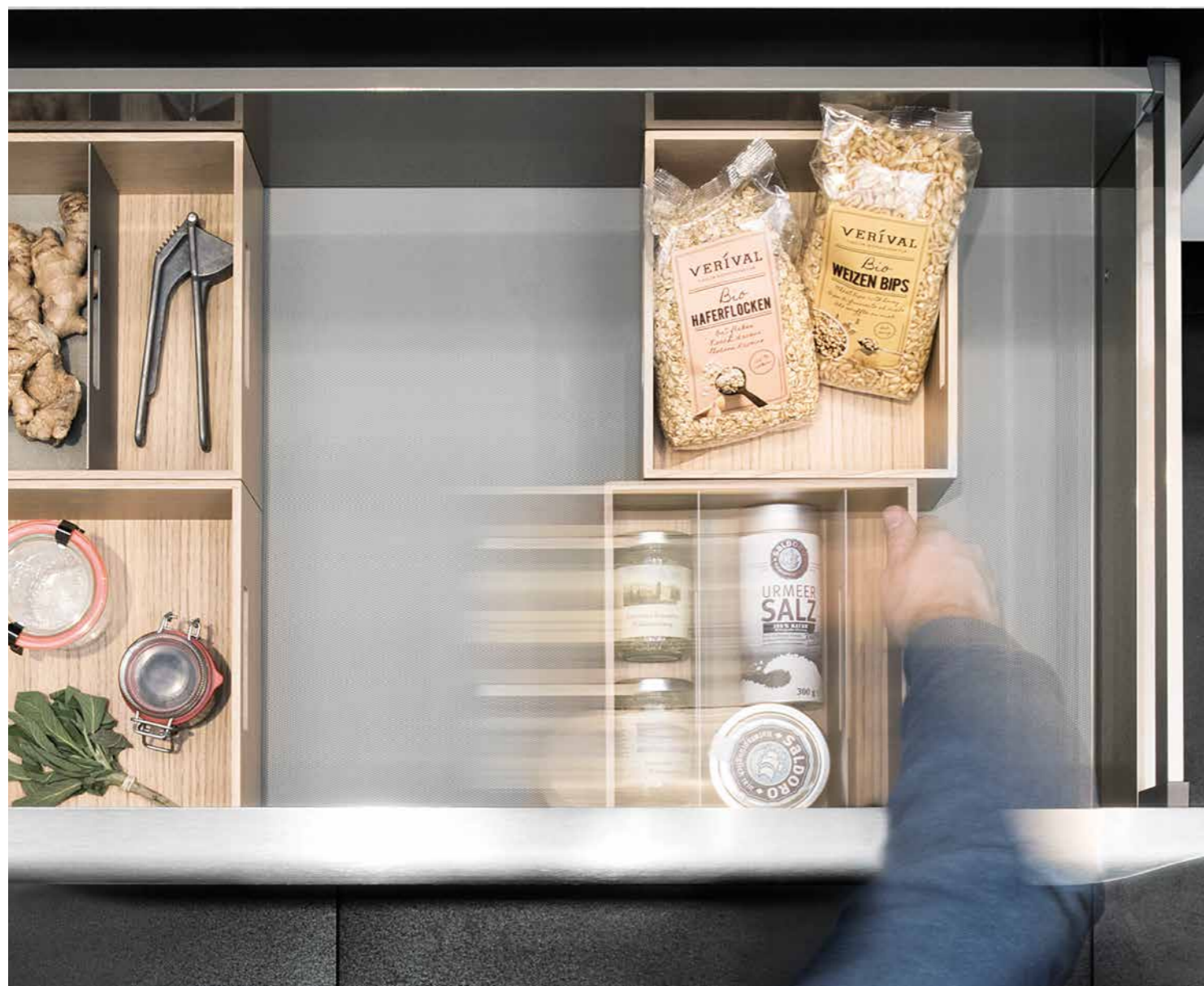

Interior organisation system **MOVE**

The internal organisation system MOVE, which is made of real wood, offers a lot of options to use the cabinet even smarter. Boxes in many sizes, cutlery trays, foil dispensers, knife holders and much more are making this concept very need. The anti-slip mats are helping to keep everything in it's spot.

Organización interior **MOVE**

Tanto los cajones de extensión total con organización interior de madera maciza y cuberteros como los cajones adicionalmente integrados son conceptos de almacenaje innovadores que facilitan el trabajo y logran el orden rápida y sencillamente.

Sistema di organizzazione interno **MOVE**

Che i cassetti siano dotati di organizzatori in legno massello o di inserti per posate e contenitori supplementari integrati, gli innovativi sistemi per l'organizzazione degli interni facilitano il lavoro ed aiutano a mettere tutto in ordine in modo facile e veloce.

Skuffeindretning **MOVE**

Skuffeindretningssystemet MOVE af massivt træ giver mange anvendelsesmuligheder takket være de variable elementer – fire rum i tre højder og to forskellige grundflader. Bestikindsats, folieafroller, knivholdere og udligningselementer runder konceptet af, og en antiskridmåtte sørger for, at tingene bliver liggende på deres plads.



Interior organisation system for pull-outs **MOVE**

Organización interior para gavetas **MOVE**

Sistema di organizzazione interno per cestoni **MOVE**

Indretning **MOVE** til udtræk

Interior organisation system **MOVE**

Organización interior **MOVE**

Sistema di organizzazione interno **MOVE**

Indretning **MOVE** til skuffer



Tall unit for appliances with special sized lift-up door

Electrical devices, that cannot be integrated in the cabinet, can be hidden behind a lift up door. Small front panels are making the recess fully accessible. The horizontal joints are therefore also reduced.

Armario columna para electrodomésticos con puerta elevable variable

Con la puerta elevable, los electrodomésticos que no se pueden integrar desaparecen detrás del frente del mueble. Los frentes de compensación permiten aprovechar el espacio sobre el hueco previsto para un electrodoméstico y se reducen las ranuras horizontales.

Colonnada incasso con anta ad apertura parallela

Con l'anta ad apertura parallela, gli elettrodomestici non incassabili scompaiono magicamente nella colonna. I pannelli di compensazione rendono pienamente utilizzabile lo spazio disponibile e riducono le fughe orizzontali.

Højskab med lift-låge til udligning

Med lift-lågen forsvinder ikke-integrerbare elapparater bag en møbelfront. Udligningsfronter tillader optimal udnyttelse af opbevaringspladsen oven over et opbevaringsrum til elapparater og reducerer de vandrette samlinger.



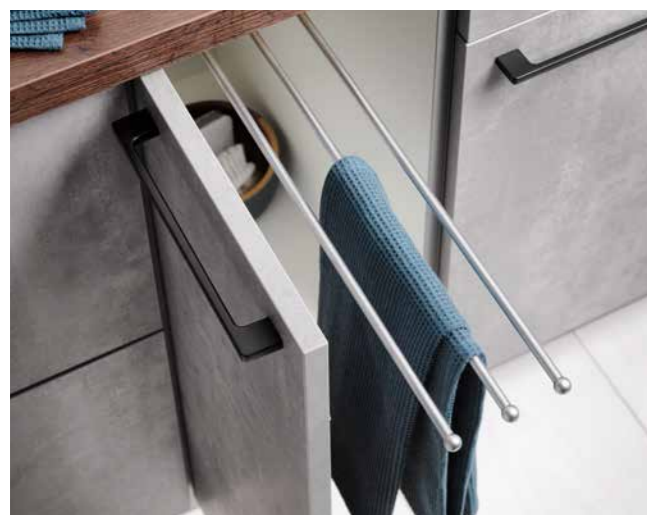

Base unit for towels and cleansing detergent

Armario bajo para paños de cocina y productos de limpieza

Base per asciugamani e detersivi

Underskab til håndklæder og rengøringsmidler



Base unit with cooking AGENT and soft-closing system

Armario bajo con cooking AGENT y cierre soft

Base con cooking AGENT e chiusura soft

Underskab med cooking AGENT og SoftClose



Base unit for provision
Clip-on shelves with fixed bottom

Armario bajo para provisiones
Bandejas colgables con estantes fijos

Base per dispensa
Ripiani con ripiano fisso agganciati

Underskab til forråd
Monteringshylder med fast bund



Base unit for provisions and bottles
with interior drawer and removable bottle-rack

Armario bajo para provisiones y botellas
con cajón interior y cesta extraíble para botellas

Base per provviste e bottiglie
con cassetto interno e portabottiglie estraibile

Underskab til forråd og flasker
med indvendig skuffe og udtagelig flaskekurv i udtrækket



Base unit with bag for baguette
Armario bajo con bolsa para pan
Base con cesto portapane
Underskab med pose til franskbrød



Tall unit for provisions with tandem swivel pull-out
 Armario de almacenaje con gaveta giratoria tándem
 Colonna dispensa con scaffale estraibile tandem
 Højskab til forråd med tandem svingudtræk



Tall unit for provisions with fully extendable pull-out and soft-closing system
 The box for the interior organiser MOVE can also be integrated.

Armario de almacenaje con extracción total y cierre soft
 Aquí también se puede integrar la caja del sistema de organización interior MOVE.

Colonna estraibile da farmacista e chiusura soft
 In questo armadio è possibile inserire i cassetti della linea MOVE.

Højskab til forråd med fuldudtræk og SoftClose
 Her kan boksen fra skuffeindretning MOVE også integreres.





Swivel shelves LeMans
with metal railing

Estantes pivotantes
LeMans
con bordes de metal

Cestoni estraibili
LeMans
con ringhierina in metallo

Svingudtræk LeMans
med metalræling



Semi-circular swivel shelves with metal railing
Estantes giratorios semicírculos con bordes de metal
Semilune estraibili con ringhierina in metallo
Halvcirkeldrejehylder med metalræling



Laminated swivel shelves
Estantes giratorios semicírculos de material sintético
Semilune estraibili in plastica
Plast halvcirkeldrejehylder

Heavy duty and totally robust:
Corner units with swing-out shelves are using every millimeter of the cabinet.

Sumamente resistentes y de gran solidez:
Armarios de rincón con estantes giratorios garantizan espacio hasta en el último rincón.

Grande portata unita a grande solidità:
Le basi angolari con piani girevoli cestoni sfruttano lo spazio anche nell'angolo più remoto

Højt belastbare og bundsolide
Hjørneskabe med svingbare drejehylder garanterer plads i det inderste hjørne

Recess equipment Linero MosaiQ
Equipamiento de entrapaño Linero MosaiQ
Accessori per nicchia Linero MosaiQ
Nicheindretning Linero MosaiQ





Waste system

A good planning reveals many well-thought-out furnishing elements to facilitate the everyday work in the kitchen.

Sistema de basura

Una buena planificación se muestra en un buen equipamiento, que nos facilita el trabajo diario.

Sistema di raccolta differenziata

Una buona progettazione si riconosce anche nei molti accessori intelligenti che aiutano ad affrontare il lavoro di tutti i giorni in cucina.

Affaldssystem

En god planlægning kommer til udtryk i mange gennemtænkte udstyrsdele, der gør arbejdet i hverdagen nemmere.



Base unit with waste system. Pull-out frame with removable waste sorter.

Armario bajo con sistema de basuras. Estructura de extracción con cubos de basura colgados.

Base con pattumiera. Telaio estraibile con portarifiuti da agganciare.

Underskab med affaldssystem. Udtræksholder med aftagelige affaldsbeholdere.



Sink base unit with waste system

Armario bajo para fregaderos con sistema de basuras

Base per lavello con pattumiera

Underskab til vask med affaldssystem



Metal shelf support with safety pin

The shelves are particularly hard-wearing and can be adjusted individually with a row of holes in the inside of the carcass.

Soporte de estantes metálico con seguro de extracción

Los suelos son sumamente resistentes y, gracias a una hilera de orificios en el armazón, pueden ajustarse individualmente.

Supporto per ripiani in metallico con dispositivo antiribaltamento

I ripiani sono molto robusti e possono essere posizionati individualmente lungo una serie di fori nella scocca.

Hyldebærer med væltesikring

Hyldeerne er specielt belastbare og kan placeres individuelt i hulrækken i korpset.

Wall unit suspension

The cupboard bracket is located at the back of the wall units and can be adjusted in three dimensions. Covering caps inside the wall unit cover the adjustment screws.

Colgador de muebles altos

Los dispositivos de suspensión de los armarios se encuentran escondidos tras la pared posterior del armario alto y se pueden ajustar en tres dimensiones. Las tapas de cubierta en el interior del armario ocultan los tornillos de ajuste.

Fissaggio dei pensili nascosto

La sospensione è invisibile, nascosta dietro lo schienale del pensile ed è regolabile in tre direzioni. Le viti di regolazione sono coperte da tappini all'interno del pensile.

Skjult skabsophæng

Skabsophænget befinder sig skjult bag overskabets bagvæg og kan justeres tredimensionelt. Blændpropper indvendigt i skabet skjuler justerskruerne.



Hinge with integrated damping

Installation and disassembling is quick and easy and requires no tools. The hinge can be adjusted in three dimensions.

Bisagra con amortiguación integrada

Los muebles se pueden montar y desmontar de forma rápida y sencilla sin herramientas. La bisagra se puede ajustar en tres dimensiones.

Cerniera con ammortizzatore integrato

Il meccanismo consente il montaggio e lo smontaggio in modo facile e veloce e senza attrezzi. La cerniera è regolabile in tre direzioni.

Hængsel med integreret dæmpning

På- eller afmontering foregår hurtigt og nemt uden brug af værktøj. Hængslet kan justeres tredimensionelt.



Wall unit with folding lift-up doors

All lift up door systems in wall units are designed to be adjusted continuously. They are easy to open and close softly. A wide range of planning options are available, as full furniture fronts or in combination with a framed front made from glass.

Armario alto con puertas plegables

Todos los sistemas giratorios de los armarios altos están diseñados de manera que pueden ajustarse progresivamente. Se pueden abrir fácilmente y se cierran con suavidad gracias a un sistema de amortiguación. Tanto como frente completo de mueble como combinado con un frente de marco de cristal, usted dispone de una gran variedad de alternativas para la planificación.

Pensile con anta a libro

Tutti i sistemi di apertura nei pensili sono progettati per essere regolati in continuo. Si aprono con facilità e si chiudono con ammortizzatore. Le ante piene o in vetro sono disponibili una vasta gamma per ogni tipo di progettazione.

Overskab med folde-lift-låge

Alle svingsystemer i overskabe er designet sådan, at de kan indstilles trinløst. De er nemme at åbne og har dæmpet lukning. Der er masser af udformningsmuligheder til rådighed, uanset om det drejer sig om en hel møbelfront eller i kombination med en ramme i glas.



Wall unit with lift-up door
Armario alto con puerta basculante
Pensile con ante ribaltabili
Overskab med svinglåge

Wall unit with flap door and illuminated base shelf LED*
Armario alto con puerta abatible y fondo luminoso LED*
Pensile con ribalta e fondo luminoso a LED*
Overskab med klap og lys i bunden med LED-teknik*



Wall unit with LED handle profile
Armario alto con perfil tirador LED
Pensile con profilo gola luminoso LED down
Overskab med LED-grebsprofil

Wall unit with LED handle profile - down
Armario alto con perfil tirador LED - down
Pensile con profilo gola luminoso LED down
Overskab med LED-grebsprofil - down

*Also available in combination with downlight LED trim handles
*También disponible en combinación con el perfil tirador LED-down
*Disponibile anche in combinazione con profilo gola luminoso LED down
*Leveres også i kombination med LED-grebsprofil - down



Under cabinet LED lighting

Iluminación LED montaje debajo los muebles

Faretto LED, montaggio sottopensile

Undermonteret LED-armatur



LED spot light with individual colour temperature change

LED recessed luminaires can be used. The recess incl. cable outlet in the shelves are made in the factory.

Lámpara LED integrada con un cambio individual de la temperatura de color

También se pueden integrar focos LED. El fresado con la salida de cables incluida en los estantes se realiza de fábrica.

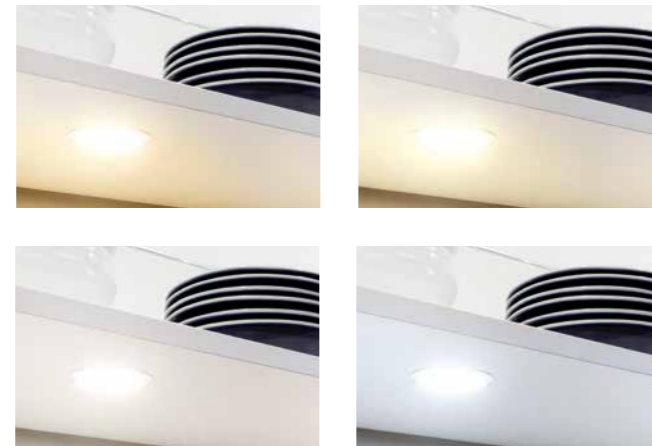

Luce LED con regolazione temperatura personalizzata

Possono essere inserite luci LED ad incasso. La fresatura e la canalina per il passaggio del cavo nel fondo vengono eseguite in fabbrica.

Indbygnings LED-armatur med individuelt farvetemperaturskift

Der kan anvendes LED-indbygningsarmaturer.

Udfræsningen inkl. kabeludgang i bunden sker fra fabrikken.



Sound system

Assembly recommendation: Install behind plinth panel; Operated via Bluetooth connection, e.g. using a smartphone or tablet.

Sistema de sonido

Recomendación de montaje detrás del zócalo; el manejo se realiza a través de conexión Bluetooth por ejemplo, con el teléfono o la tabla.

Sound System

Montaggio consigliato dietro la fascia zoccolo; Comandi attivabili tramite connessione Bluetooth, per es. da smartphone/tablet.

Soundsystem

Anbefalet montering bag sokkelafblændingen.

Betjening sker via bluetooth-forbindelse f.eks. via smartphone eller tablet.

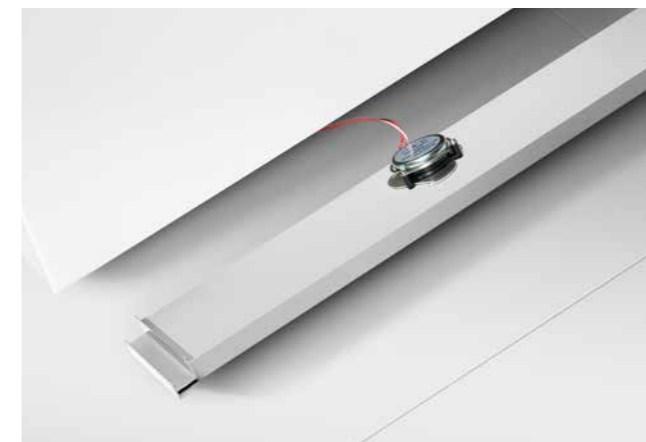









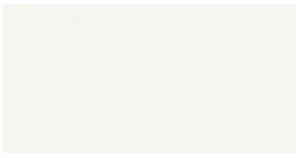



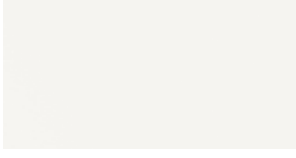

Qi charger for inductive load

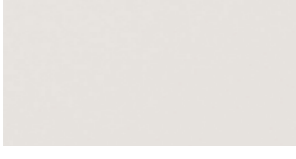
Qi cargador (Qi Charger) para carga inductiva

Qi Charger per ricarica ad induzione

Charger til induktiv opladning

<p>038</p>  <p>White Blanco Bianco Hvid</p>	<p>302</p>  <p>Shiny white Blanco brillante Bianco lucido Hvid højglans</p>	<p>025</p>  <p>Magnolia Magnolia Magnolia Magnolia</p>	<p>311</p>  <p>Shiny magnolia Magnolia brillante Magnolia lucido Magnolia højglans</p>
<p>052</p>  <p>Polar white Blanco polar Bianco polare Polarhvid</p>	<p>209</p>  <p>Shiny polar white Blanco polar brillante Bianco polare lucido Polarhvid højglans</p>	<p>340</p>  <p>Cashmere Cachemir Cachemire Kasmir</p>	<p>345</p>  <p>Shiny cashmere Cachemir brillante Cachemire lucido Kasmir højglans</p>
<p>176</p>  <p>Taupe Satén Satin Satin</p>	<p>359</p>  <p>Shiny taupe Satén brillante Satin lucido Satin højglans</p>	<p>078</p>  <p>Pearl grey Gris perla Grigio perla Perlegrå</p>	<p>376</p>  <p>Graphite Grafito Grafite Grafit</p>
<p>024</p>  <p>Stainless steel col. Color acero inox. Colore acciaio inox Rustfritstål farvet</p>	<p>233</p>  <p>Natural vintage oak Roble envejecido natural Rovere antico natura Natural Vintage Eg</p>		

Front overview

The variety of designs is second to none. You can freely choose and combine finishing materials. A large selection of designs is also available for 'handlelessART'.



Frentes – Visión de conjunto

La diversidad de muebles satisface todos los deseos. Puede elegir y combinar libremente los diferentes materiales. También se suministra una gran diversidad de los programas para el sistema ART sin asas.

Elenco modelli

La varietà di modelli disponibili non lascia alcun desiderio insoddisfatto. Potrete scegliere e combinare a piacimento i differenti materiali. Anche per la cucina con la gola sono disponibili diversi modelli.

Fronter – oversigt

Forskellige modeller opfylder alle ønsker. Du kan frit vælge og kombinere med materialeversionerne. Mange af programmerne er også tilgængelige til grebsløstART.

Our anti-finger print surfaces are produced with an innovative varnishing method. This lacquer has a particular microsurface particulate structure, which seamlessly aligns to each other. This lacquering method ensures quick evaporation of water based finger prints.

Las superficies antihuellas se obtienen con un proceso de lacado innovador. La pintura contiene partículas especiales que se unen sin dejar huecos. La textura especial de la superficie con una capa de pintura asegura una rápida «evaporación» del sudor de las manos.

Le superfici anti-impronta sono trattate con un innovativo procedimento di laccatura. Questa è composta da speciali particelle che si allineano perfettamente tra di loro. Questa particolare struttura microscopica della laccatura fa sì che l'umidità del sudore sulla punta delle dita evapori immediatamente.

Antifingeraftryksoverfladerne fremstilles ved hjælp af en innovativ belægningsproces. Lækken indeholder specielle partikler, der ligger ved siden af hinanden uden mellemrum. Denne specielle mikrooverfladestruktur i laklaget sikrer, at håndsvet "fordamper" hurtigt.

PerfectSense





The high-quality PerfectSense surfaces convince with visual perfection as well as high resilience and durability. The surfaces finished with a layer of lacquer are giving the kitchen an exclusive and noble character.

Las superficies PerfectSense de alta calidad destacan por su perfección visual, así como por su gran durabilidad y resistencia. Las superficies con un acabado de pintura le dan un carácter exclusivo y noble a tu cocina.

Le preziose superfici PerfectSense si fanno apprezzare sia per la perfetta estetica, sia per le doti di elevata robustezza e resistenza. La speciale laccatura delle superfici conferisce alla cucina un carattere raffinato ed esclusivo.



PerfectSense-overfladerne af høj kvalitet overbeviser med visuel perfektion, høj modstandskraft og lang holdbarhed. De lakerede overflader giver køkkenet et eksklusivt og raffineret udtryk.

UNO PGO Laminate/fine structured
Material sintético/textura fina
Laminato/rivestimento melaminico
Laminatstruktur

						
Polar white (ART) Blanco polar (ART) Bianco polare (ART) Polarhvid (ART)	White (ART) Blanco (ART) Bianco (ART) Hvid (ART)	Magnolia (ART) Magnolia (ART) Magnolia (ART) Magnolia (ART)	Taupe (ART) Satén (ART) Satin (ART) Satin (ART)	Cashmere (ART) Cachemir (ART) Cachemire (ART) Kasmir (ART)	Light grey (ART) Gris luminoso (ART) Grigio chiaro (ART) Lysgrå (ART)	Pearl grey (ART) Gris perla (ART) Grigio perla (ART) Perlegrå (ART)

UNO PGO Laminate/fine structured
Material sintético/textura fina
Laminato/rivestimento melaminico
Laminatstruktur

MAX

	
Chili red (ART) Chile rojo (ART) Peperoncino rosso (ART) Chilirød (ART)	Graphite (ART) Grafito (ART) Grafite (ART) Grafit (ART)

BALI PG1 Laminate matex surface resp. woodstruktur
Melamina Matex resp. estructura de la madera
Laminato/superficie materica resp. struttura legno
Laminatstræstruktur

MAX

			
Nordic oak (ART) Roble nórdico (ART) Rovere nordica (ART) Nordisk Eg (ART)	Oak sand (ART) Roble arena (ART) Rovere sabbia (ART) Sand Eg (ART)	Silk grey oak (ART) Roble gris seda (ART) Rovere grigio seta (ART) Silkegrå (ART)	Summer oak (ART) Roble de verano (ART) Farnia (ART) Sommer Eg (ART)

COMET PG1 Laminate structured/Putty concrete
Material sintético estructurado/Hormigón enfoscado
Laminato strutturata/Calcestr. spatolato
Laminatstruktur/Beton

MAX

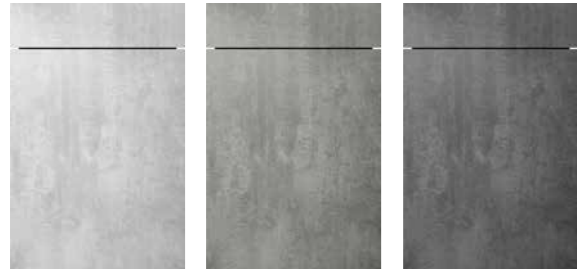

Opal grey (ART)
Gris opalino (ART)
Grigio opale (ART)
Opalgrå (ART)

Pearl grey (ART)
Gris perla (ART)
Grigio perla (ART)
Perlegrå (ART)

Graphite (ART)
Grafito (ART)
Grafite (ART)
Grafit (ART)

METEOR PG1 Laminate ceramic fine structured
Estructura de cerámica plástica
Laminato struttura ceramica
Laminat keramikstruktur

MAX

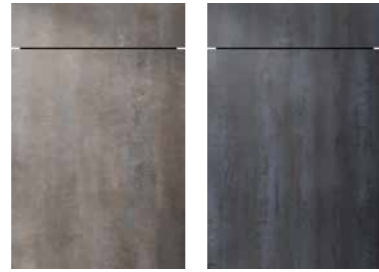

Oxide (ART)
Oxido (ART)
Ossido (ART)
Oxid (ART)

Black steel (ART)
Acero negro (ART)
Acciaio nero (ART)
Sort Stål (ART)

NEO PG1 Shiny laminate
Melamina brill.
Laminato lucido
Laminat højglans

MAX



White (ART)
Blanco (ART)
Bianco (ART)
Hvid (ART)

Magnolia (ART)
Magnolia (ART)
Magnolia (ART)
Magnolia (ART)

Taupe (ART)
Satén (ART)
Satin (ART)
Satin (ART)

VANCOUVER PG1 Laminate/synchronous pore
Material sintético/superficie poro sincrónico
Laminato sincroporo/materico
Laminat synkronpore

MAX



Sand vintage oak (ART)
Roble envejecido arena (ART)
Rovere antico sabbia (ART)
Sand Vintage Eg (ART)

Natural vintage oak (ART)
Roble envejecido natural (ART)
Rovere antico natura (ART)
Natural Vintage Eg (ART)

TORONTO PG1 Laminate/synchronous pore resp. woodstruktur
Material sintético/superficie poro sincrónico resp. estructura de la madera
Laminato sincroporo/materico resp. struttura legno
Laminatstruktur

MAX



Sand vintage oak (ART)
Roble envejecido arena (ART)
Rovere antico sabbia (ART)
Sand Vintage Eg (ART)

Natural vintage oak (ART)
Roble envejecido natural (ART)
Rovere antico natura (ART)
Natural Vintage Eg (ART)

Cognac vintage oak (ART)
Roble envejecido coñac (ART)
Rovere antico cognac (ART)
Cognac Vintage Eg (ART)

Grey oak (ART)
Roble gris (ART)
Rovere grigio (ART)
Grå Eg (ART)

Black oak (ART)
Roble negro (ART)
Rovere nero (ART)
Sort Eg (ART)

LASER SOFT PG2 Lacquer laminate ultra matt
Laca laminada ultramate
Foglio polimerico laccato opaco
Maling laminat mat

MAX

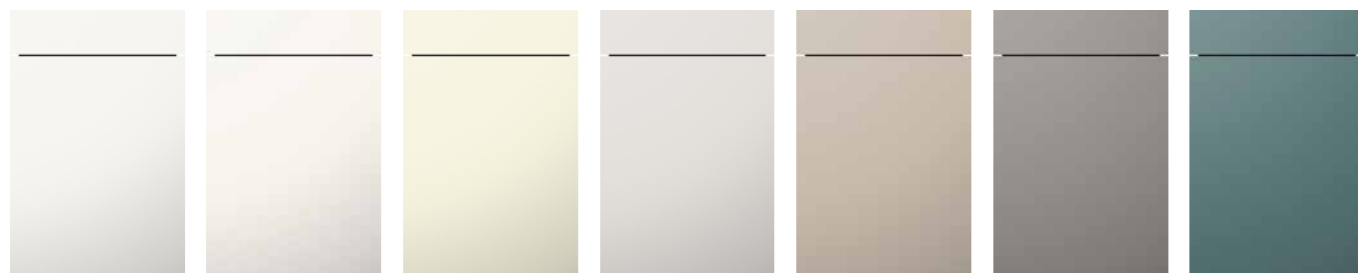

Polar white (ART)
Blanco polar (ART)
Bianco polare (ART)
Polarhvid (ART)

White (ART)
Blanco (ART)
Bianco (ART)
Hvid (ART)

Magnolia (ART)
Magnolia (ART)
Magnolia (ART)
Magnolia (ART)

Taupe (ART)
Satén (ART)
Satin (ART)
Satin (ART)

Cashmere (ART)
Cashemir (ART)
Cachemire (ART)
Kasmir (ART)

Pearl grey (ART)
Gris perla (ART)
Grigio perla (ART)
Perlegrå (ART)

Aquamarine (ART)
Aguamarina (ART)
Aquamarina (ART)
Havblå (ART)

LASER SOFT PG2 Lacquer laminate ultra matt
Laca laminada ultramate
Foglio polimerico laccato opaco
Maling laminat mat

MAX



Graphite (ART)
Grafito (ART)
Grafite (ART)
Grafit (ART)

Black (ART)
Negro (ART)
Nero (ART)
Sort (ART)

LASER BRILLANT PG2 Lacquer laminate high gloss
Laca laminada alto brillo
Foglio polimerico laccato lucido
Maling laminat højglans

MAX



Polar white (ART)
Blanco polar (ART)
Bianco polare (ART)
Polarhvid (ART)

White (ART)
Blanco (ART)
Bianco (ART)
Hvid (ART)

Magnolia (ART)
Magnolia (ART)
Magnolia (ART)
Magnolia (ART)

Taupe (ART)
Satén (ART)
Satin (ART)
Satin (ART)

Cashmere (ART)
Cashemir (ART)
Cachemire (ART)
Kasmir (ART)

LASER BRILLANT PG2 Lacquer laminate high gloss
Laca laminada alto brillo
Foglio polimerico laccato lucido
Maling laminat højglans

MAX

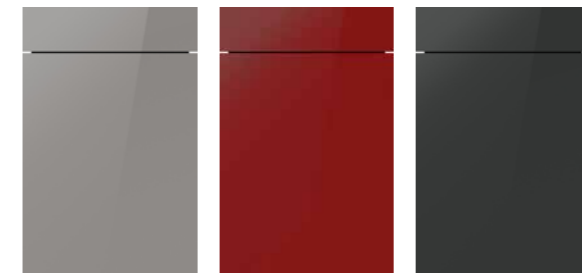

Pearl grey (ART)
Gris perla (ART)
Grigio perla (ART)
Perlegrå (ART)

Chili red (ART)
Chile rojo (ART)
Peperoncino rosso (ART)
Chilirød (ART)

Graphite (ART)
Grafito (ART)
Grafite (ART)
Grafit (ART)

MALAGA PG3 Laminated matt
Polilaminado mate
Foglio polimerico opaco
Laminat mat

NEW



White
Blanco
Bianco
Hvid

Taupe
Satén
Satin
Satin

Graphite
Grafito
Grafite
Grafit

LOTUS PG3 Laminated matt
Polilaminado mate
Foglio polimerico opaco
Laminat mat

BREDA PG3 Laminated matt
Polilaminado mate
Foglio polimerico opaco
Laminat mat

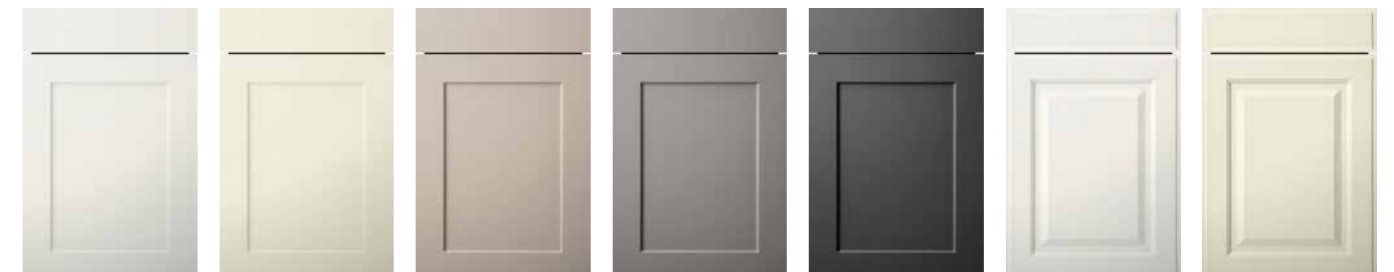

White
Blanco
Bianco
Hvid

Magnolia
Magnolia
Magnolia
Magnolia

Cashmere
Cashemir
Cachemire
Kasmir

Pearl grey
Gris perla
Grigio perla
Perlegrå

Graphite
Grafito
Grafite
Grafit

White
Blanco
Bianco
Hvid

Magnolia
Magnolia
Magnolia
Magnolia

LOFT PG3 Soft lacquer
Lacado soft
Laccatura opaca
Lakeret blødt

TOUCHfree
with touchpanel

MAX

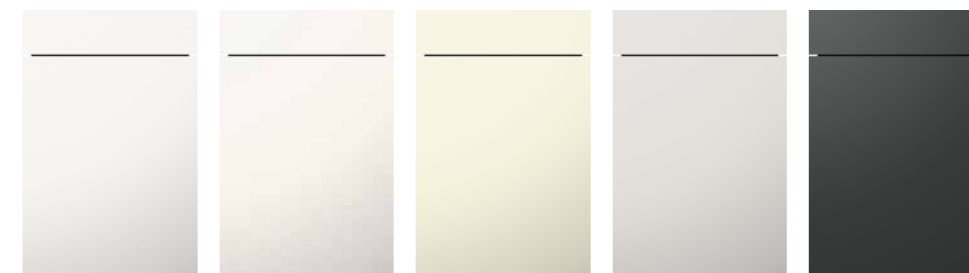

Polar white (ART)
Blanco polar (ART)
Bianco polare (ART)
Polarhvid (ART)

White (ART)
Blanco (ART)
Bianco (ART)
Hvid (ART)

Magnolia (ART)
Magnolia (ART)
Magnolia (ART)
Magnolia (ART)

Taupe (ART)
Satén (ART)
Satin (ART)
Satin (ART)

Graphite (ART)
Grafito (ART)
Grafite (ART)
Grafit (ART)

MERKUR PG3 Satin lacquerLaca mate satinada
Laccato opaco
Lakeret mat

PerfectSense

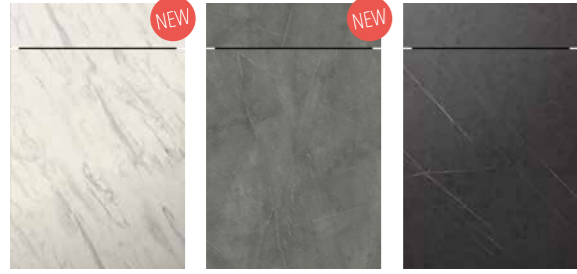
MAX

Carrara white (ART)
Carrara blanco (ART)
Carrara bianco (ART)
Carrara Hvid (ART)

Marble grey (ART)
Mármol gris (ART)
Marmo grigio (ART)
Marmor Grå (ART)

Marble dark (ART)
Mármol oscuro (ART)
Marmo scuro (ART)
Mørk Marmor (ART)

STEEL PG3 Lacquer laminate metallic brushedLaminado lacado metalic cepillado
Foglio polimerico laccato metallo spazzolato
Malet laminat børstet metallisk**MAX**

Metalic light brushed (ART)
Metálico cepillado luminoso (ART)
Metallo spazzolato chiaro (ART)
Lysmetallic børstet (ART)

Metalic dark brushed (ART)
Metalico oscuro cepillado (ART)
Metallo spazzolato scuro (ART)
Mørkmetallic børstet (ART)

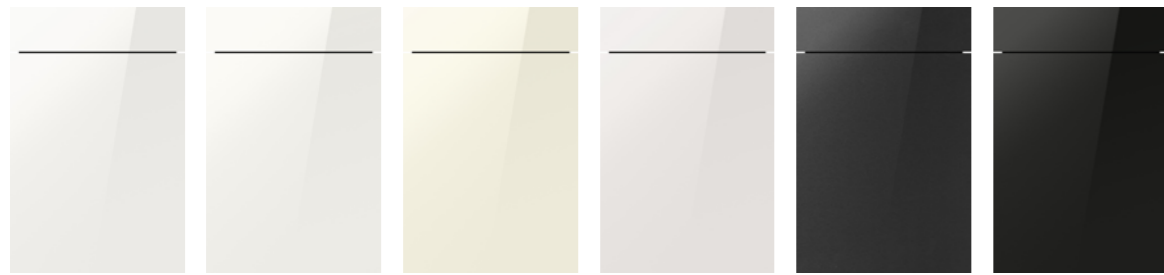
CRISTALL PG4 High gloss lacquerLacado alto brillo
Laccato lucido brillante
Højglanslakeret**MAX**

Polar white (ART)
Blanco polar (ART)
Bianco polare (ART)
Polarhvid (ART)

White (ART)
Blanco (ART)
Bianco (ART)
Hvid (ART)

Magnolia (ART)
Magnolia (ART)
Magnolia (ART)
Magnolia (ART)

Taupe (ART)
Satén (ART)
Satin (ART)
Satin (ART)

Metallic carbon (ART)
Carbono metálico (ART)
Carbono metallico (ART)
Metalliccarbon (ART)

Black (ART)
Negro (ART)
Nero (ART)
Sort (ART)

BOSTON PG4 Laminate matex surface resp. woodstrukturMelamina Matex resp. estructura de la madera
Laminato/superficie materica risp. struttura legno
Laminatstruktur**LUMOS PG5** High gloss lacquerLacado alto brillo
Laccato lucido brillante
Højglanslakeret**MAX****LUNA PG5** High gloss lacquerLacado alto brillo
Laccato lucido brillante
Højglanslakeret**MAX**

Magnolia matex
Magnolia matex
Magnolia matex
Magnolia Matex

Oak sand
Roble arena
Rovere sabbia
Sand Eg

White
Blanco
Bianco
Hvid

White
Blanco
Bianco
Hvid

FARO PG5 High gloss lacquerLacado alto brillo
Laccato lucido brillante
Højglanslakeret**MAX****GRANADA PG6** High gloss lacquerLacado alto brillo
Laccato lucido brillante
Højglanslakeret

Polar white (ART)
Blanco polar (ART)
Bianco polare (ART)
Polarhvid (ART)

White (ART)
Blanco (ART)
Bianco (ART)
Hvid (ART)

Magnolia (ART)
Magnolia (ART)
Magnolia (ART)
Magnolia (ART)

Taupe (ART)
Satén (ART)
Satin (ART)
Satin (ART)

White
Blanco
Bianco
Hvid

BRISTOL PG7 Ash lacquer real wood frame veneered center panelFresno lacado marco macizo plafón chapado
Frassino laccato telaio massello fodrina impiallacciata
Lakeret rammelåge i ask

White
Blanco
Bianco
Hvid

Magnolia
Magnolia
Magnolia
Magnolia

Taupe
Satén
Satin
Satin

Cashmere
Cachemir
Cachemire
Kasmir

Agate blue
Ágata azul
Agata blu
Agatblå

Velvet blue
Azul seda
Blu velluto
Fløjsblå

Pearl grey
Gris perla
Grigio perla
Perlegrå

BRISTOL PG7 Ash lacquer real wood frame veneered center panelFresno lacado marco macizo plafón chapado
Frassino laccato telaio massello fodrina impiallacciata
Lakeret rammelåge i ask

Graphite
Grafito
Grafite
Grafit

Pastel green
Verde pastel
Verde pastello
Pastelgrøn

Crimson red
Rojo carmín
Rosso carminio
Purpurrød

Black
Negro
Nero
Sort

HAMPTON PG7 Ash lacquer real wood frame veneered center panelFresno lacado marco macizo plafón chapado
Frassino laccato telaio massello fodrina impiallacciata
Lakeret rammelåge i ask

White
Blanco
Bianco
Hvid

Magnolia
Magnolia
Magnolia
Magnolia

Taupe
Satén
Satin
Satin

Cashmere
Cachemir
Cachemire
Kasmir

Agate blue
Ágata azul
Agata blu
Agatblå

Velvet blue
Azul seda
Blu velluto
Fløjsblå

Pearl grey
Gris perla
Grigio perla
Perlegrå

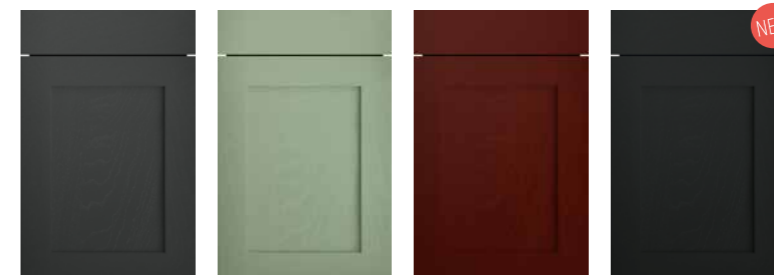
HAMPTON PG7 Ash lacquer real wood frame veneered center panelFresno lacado marco macizo plafón chapado
Frassino laccato telaio massello fodrina impiallacciata
Lakeret rammelåge i ask

Graphite
Grafito
Grafite
Grafit

Pastel green
Verde pastel
Verde pastello
Pastelgrøn

Crimson red
Rojo carmín
Rosso carminio
Purpurrød

Black
Negro
Nero
Sort



18 Arizona pine effect
Pino arizona repro.
Effetto pino Arizona
Arizona fyrtræ effekt

08 Silk grey oak effect
Roble gris seda repro.
Effetto rovere grigio seta
Silkegrå effekt

25 Oak sand effect
Roble arena repro.
Effetto rovere sabbia
Sand Eg effekt

69 Natural butcherblock effect
Tajadero natural repro.
Effetto butcherblock list. nat.
Naturlig Skærebret effekt

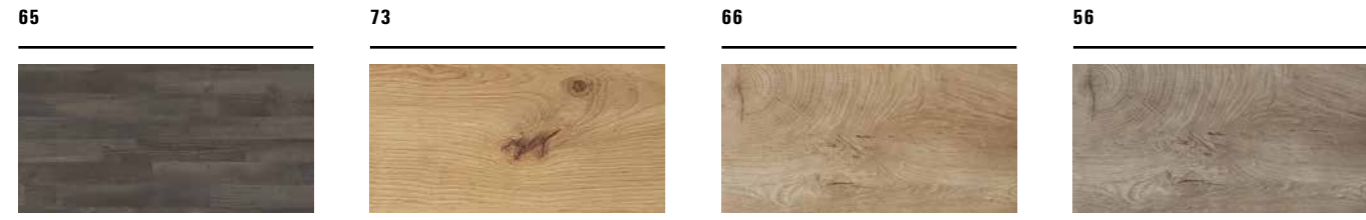

65 Rustic butcherblock effect
Tajadero rústico repro.
Effetto butcherblock list. rust.
Rustik Skærebret effekt

73 Summer oak effect
Roble de verano repro.
Effetto farnia
Sommer Eg effekt

66 Natural oak grain-cut timber effect
Roble duramen natural repro.
Effetto rovere durame natura
Natur Eg Endetræ effekt

56 Grey oak grain-cut timber effect
Roble duramen gris repro.
Effetto rovere durame grigio
Grå Eg Endetræ effekt



129 Natural vintage oak effect
Roble envejecido natural repro.
Effetto rovere antico natura
Natural Vintage Eg effekt

123 Cognac vintage oak effect
Roble envejecido coñac repro.
Effetto rovere antico cognac
Cognac Vintage Eg effekt

128 Grey oak effect
Roble gris repro.
Effetto rovere grigio
Grå Eg effekt

12 Ontario oak effect
Roble ontario repro.
Effetto rovere ontario
Ontario Eg effekt



105 Vintage oak effect
Roble vintage repro.
effetto rovere vintage
Vintage Eg effekt

114 Walnut effect
Nogal repro.
Noce vintage
Valnød effekt

120 Mountain oak effect
Roble montaña repro.
Effetto rovere di montagna
Mountain Eg effekt

107 PerfectSense
Crystal white PerfectSense
Blanco cristalino PerfectSense
Bianco cristallo PerfectSense
Krystal Hvid PerfectSense

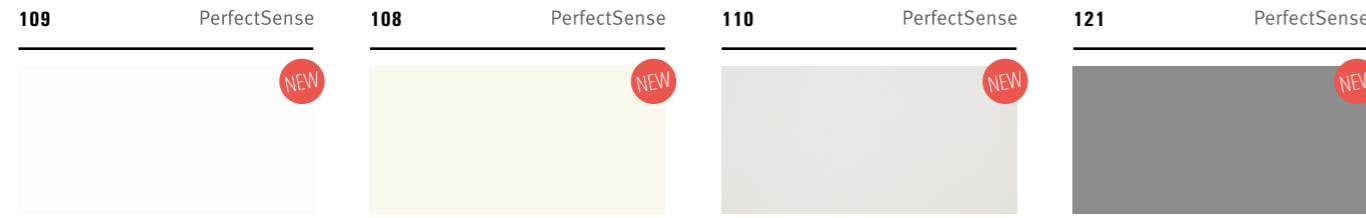

109 PerfectSense
Polar white PerfectSense
Blanco polar PerfectSense
Bianco polare PerfectSense
Polarhvid PerfectSense

108 PerfectSense
White PerfectSense
Blanco PerfectSense
Bianco PerfectSense
Hvid PerfectSense

110 PerfectSense
Taupe PerfectSense
Satén PerfectSense
Satin PerfectSense
Satin PerfectSense

121 PerfectSense
Pearl grey PerfectSense
Gris perla PerfectSense
Grigio perla PerfectSense
Perlegrå PerfectSense

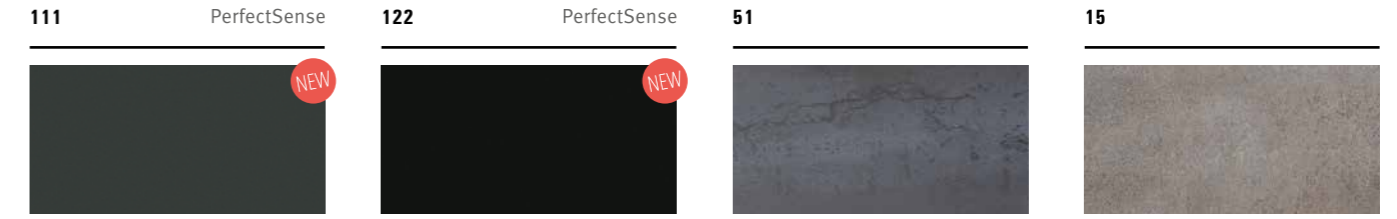

111 PerfectSense
Graphite PerfectSense
Grafito PerfectSense
Grafite PerfectSense
Grafit PerfectSense

122 PerfectSense
Black PerfectSense
Negro PerfectSense
Nero PerfectSense
Sort PerfectSense

51 Black steel
Acero negro
Acciaio nero
Sort Stål

15 Oxide
Óxido
Ossido
Oxid



200 Stainless steel coloured brushed
Color acero inoxidable cepillado
Color acciaio inox spazzolato
Rustfritstål farvet

106 Niagara
Niagara
Niagara
Niagara

33 Ventura
Ventura
Ventura
Ventura

27 Mica slate
Micacita
Micascito
Micaskifer

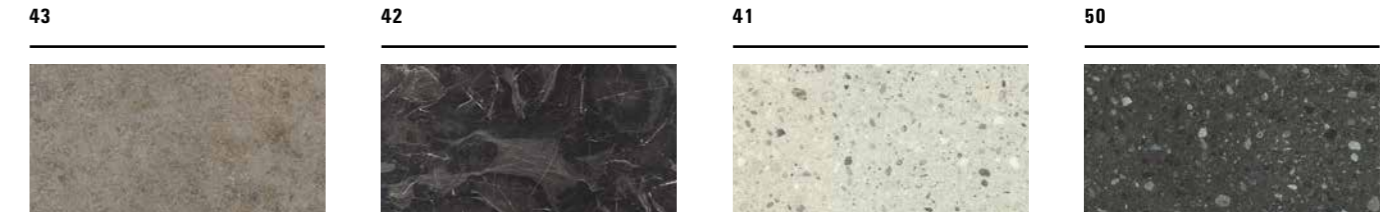

43 Salento grey beige
Salento beige gris
Salento grigio beige
Salento gråbeige

42 Imperia brown
Imperia marrón
Imperia marrone
Imperiabrun

41 Light terrazzo
Terrazo claro
Terrazzo chiaro
Lys Terazzo

50 Dark terrazzo
Terrazo oscuro
Terrazzo scuro
Mørk Terazzo

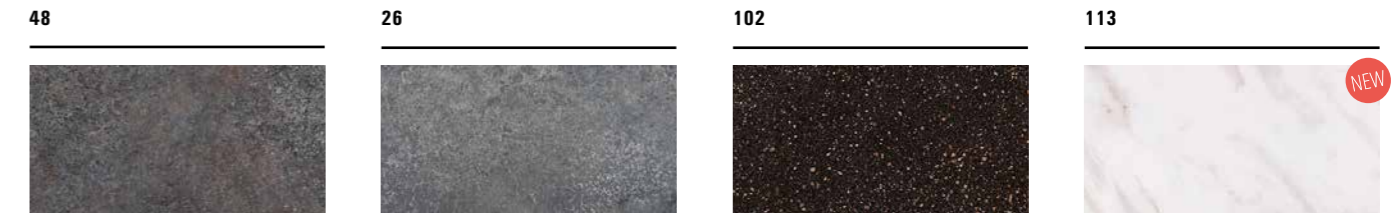

48 Aurora
Aurora
Aurora
Aurora

26 Terra
Tierra
Terra
Terra

102 Nero
Nero
Nero
Nero

113 Carrara white PerfectSense
Carrara blanco PerfectSense
Carrara bianco PerfectSense
Carrara hvid PerfectSense



112 PerfectSense
Marble grey PerfectSense
Mármol gris PerfectSense
Marmo grigio PerfectSense
Marmor Grå PerfectSense

119 PerfectSense
Marble dark PerfectSense
Mármol oscuro PerfectSense
Marmo scuro PerfectSense
Mørk Marmor PerfectSense

116 Luna dark
Luna oscuro
Luna scura
Luna mørk

24 Marble black
Mármol negro
Marmo nero
Sort marmor

95



Putty concrete opal grey
Hormigón enfoscado gris opalino
Calcestruzzo spatolato grigio opale
Beton opalgrå

39



Putty concrete pearl grey
Hormigón enfoscado gris perla
Calcestruzzo spatolato grigio perla
Beton perlegrå

101



Putty concrete graphite
Hormigón enfoscado grafito
Calcestruzzo spatolato grafite
Beton grafit

Handles

Besides single handles and knobs, there are handle systems available, that are matching the cabinet widths.

Tiradores

Además de botones y tiradores, hay muchos sistemas de agarre, que se suministran conforme a las anchuras del armario.

Maniglie

Oltre a pomelli e maniglie, sono possibili tanti sistemi di maniglia, abbinabili in base alla larghezza del armadi.

Greb

Ud over knopper og greb findes der mange grebssystemer, der leveres passende til skabsbredderne.

105



343



308



440



302



312



344



111



378



311



446



304



318



359



112



340



424



524



306



319



371



117



409



433



301



307



332



372



NEW

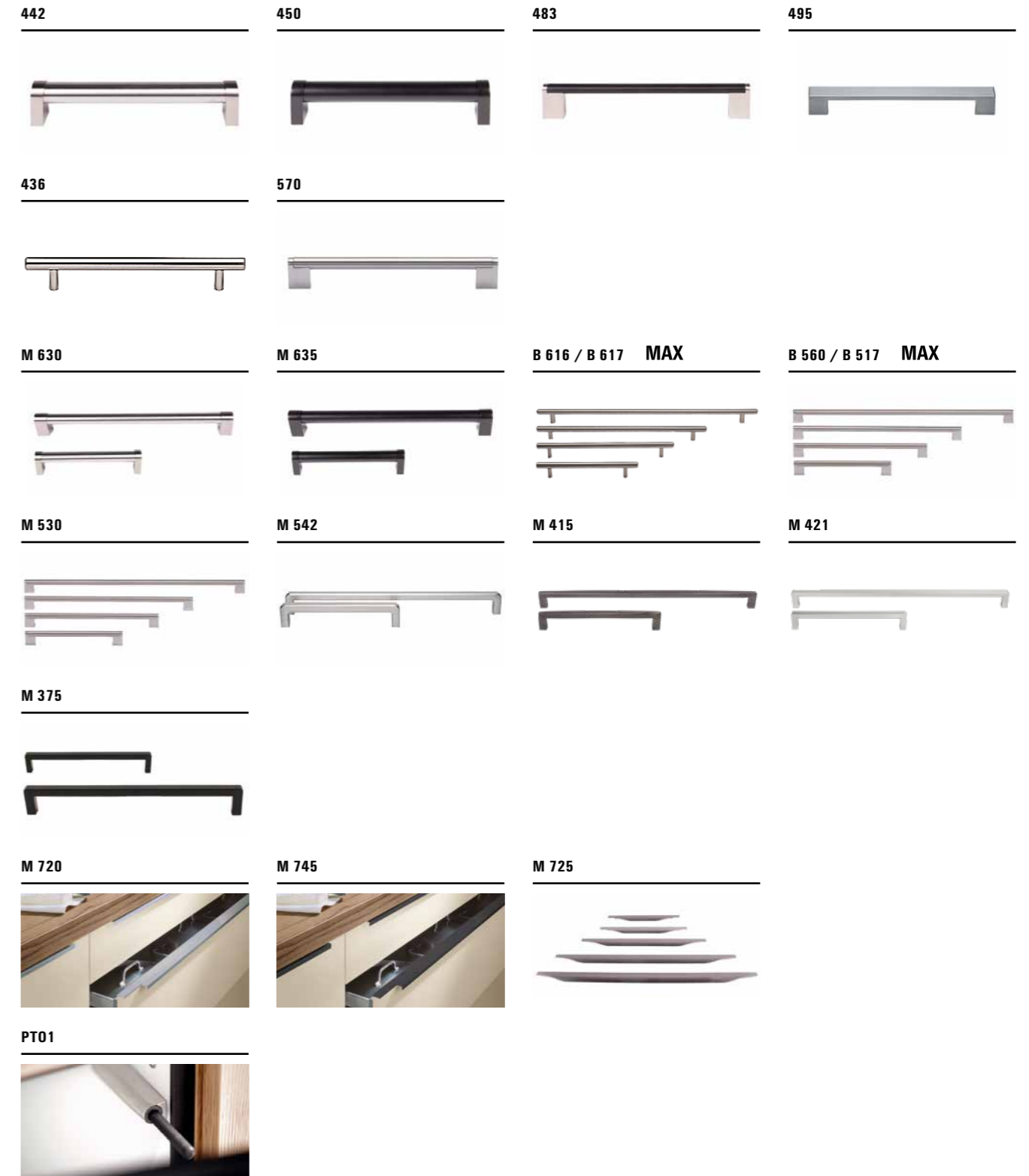



With PURemission we are setting new exceptional standards!

Advanced medicine, healthy food and a balanced environment: all of these factors make a major contribution to a healthy way of life. The drawbacks: stress and certain materials can lead to intolerances and pressure. Consumers are more sensitive than ever to topics such as formaldehyde.

Wood naturally contains formaldehyde. This can leak into the air in small quantities. We acknowledge the fact that we are currently one of the largest kitchen manufacturers, providing wood-based materials with the lowest emissions!

Through careful selection of timber materials and suppliers, since September 2017 we were able to change complete stock and process wood-based materials, where the formaldehyde content has been drastically reduced. The European standard is largely undercut and the high American standards are fulfilled by 100 percent.

PURemission stands for clean indoor air and quality at the highest level.

¡Con PURemission establecemos nuevos estándares!

El avance en la medicina, una alimentación sana y también un entorno saludable contribuyen en gran medida a un modo de vida sano. Por otra parte: el estilo de vida, el estrés y determinados materiales pueden provocar intolerancias y un alto grado de estrés. Los consumidores se muestran más sensibles que nunca ante temas como el formaldehído.

La madera natural contiene formaldehído, el cual también se expulsa al exterior en bajas cantidades.

Con nuestras cocinas tenemos en cuenta estos hechos: ¡actualmente somos uno de los mayores fabricantes de muebles de cocina con todos los materiales de madera con las emisiones más bajas!

Gracias a una esmerada selección de los materiales de madera y de nuestros proveedores, en septiembre de 2017 se logró cambiar todo el inventario y procesar exclusivamente materiales de madera cuyo porcentaje de formaldehído fue reducido drásticamente. La norma europea queda en su mayor parte por debajo y los elevados estándares americanos se cumplen al 100 por cien.

PURemission representa un aire ambiental limpio y una calidad al máximo nivel.

Con PURemission abbiamo creato nuovi standard!

I progressi nella medicina, un'alimentazione sana e un ambiente salutare danno un grande contributo per migliorare lo stile di vita. Gli aspetti negativi: lo stress e determinati materiali possono causare intolleranze e pressioni eccessive. I consumatori oggi sono sensibili più che mai su determinati argomenti, come ad esempio la formaldeide.

Il legno per sua natura può contenere formaldeide e la rilascia in piccole quantità anche verso l'esterno. Noi teniamo conto di questo aspetto ed attualmente tra i produttori di cucine componibili più grandi siamo quelli che impiegano materiali derivati del legno con le emissioni più basse!

Grazie ad una selezione accurata e consapevole delle materie prime e dei nostri fornitori, è stato possibile convertire l'intero stock già a settembre 2017 e lavorare esclusivamente materiali di derivazione del legno con un contenuto di formaldeide drasticamente ridotto. Le emissioni dei nostri prodotti sono sensibilmente al di sotto dello standard europeo e soddisfano al 100 % anche gli elevati standard americani.

PURemission è il simbolo per un'aria pulita in casa e per una qualità ai massimi livelli.

Vi sætter nye standarder – med PURemission!

Medicinske fremskridt, en alsidig kost samt et passende miljø bidrager i stort omfang til en bedre levevis. Bagsiden af medaljen: Livsstil, stress og visse stoffer kan medføre intolerance og stressbelastning. Forbrugere er mere end nogensinde tidligere overfølsomme over for emner som f.eks. formaldehyd.

Træ indeholder fra naturens hånd formaldehyd. Formaldehyd slipper også ud i det fri i små mængder.

Det tager vi højde for: Aktuelt er vi en af de største køkkenproducenter, der benytter træmateriale med den laveste emission!

Gennem et omhyggeligt og ansvarsbevidst valg af træmaterialer og leverandører er det lykkedes for os, allerede tilbage i september 2017, at omstille hele lagerbeholdningen, så vi kun forarbejder træ, hvor indholdet af formaldehyd er nedbragt drastisk. For det meste ligger vi under den europæiske standard, og de skrappe amerikanske standarder overholdes 100 procent.

PURemission står for ren indendørs luft og kvalitet på højeste niveau.



PUResist – waterproof edges

What happens with the edges of our kitchen cabinets when they are exposed to a lot of water steam? Thanks to PUResist our innovative and high-quality bonding technology, the simple answer is: nothing!

PUResist guarantees the highest quality characteristics: the edges of our kitchen furniture are water-repellent, resistant and have an excellent appearance due to the invisible joint. And the glue of those edges? Formaldehyde and solvent-free!

PUResist offers

- Protection against the ingress of moisture, e.g. at the cooking and sink areas
- Strong adhesion between the wooden materials and the edges
- An excellent look and feel because of invisible joints
- Best quality characteristics for all edges

PUResist and PURemission: all-round protection for your kitchen and for you.

Mostramos los cantos, con PUResist

¿Qué ocurre en realidad con los cantos de los armarios de cocina cuando se exponen al vapor? Gracias a nuestra innovadora tecnología de encolado de gran calidad PUResist la respuesta es sencilla: ¡nada!

PUResist garantiza las características máximas de calidad: los cantos de nuestros muebles de cocina repelen el vapor, son resistentes y, gracias a las juntas de visibilidad cero, presentan un aspecto excelente.

¿Y el encolado? ¡Libre de formaldehído y disolventes!

PUResist ofrece

- protección contra la penetración de la humedad, por ejemplo en la zona de cocción y del fregadero
- una fuerte adhesión entre el material de madera y los cantos
- excelente óptica gracias a la llamada «junta cero visible»
- extraordinarias características de calidad en todos los cantos

PUResist y PURemission: protección integral para nuestras cocinas y para usted.

PUResist: la sicurezza di una bordatura perfetta

Cosa accade ai bordi dei mobili della cucina quando vengono esposti al vapore acqueo? Grazie alla nostra innovativa e valida tecnologia di bordatura PUResist, la risposta è semplice: assolutamente niente!

PUResist garantisce i massimi requisiti di qualità: i bordi dei nostri mobili sono idrorepellenti, resistenti ed esteticamente insuperabili grazie alla giunzione invisibile. E la colla? Priva di formaldeide e di solventi!

PUResist garantisce

- protezione dalla penetrazione di umidità, come nella zona cottura e lavaggio
- una forte aderenza tra materiale di legno e bordo
- un'estetica straordinaria grazie alla giunzione invisibile
- caratteristiche di qualità superiore su tutti i bordi

PUResist e PURemission: protezione completa per le nostre cucine e per voi.

Vi viser kant – med PUResist

Hvad sker der egentlig med kanterne på køkkenskabe, når de udsættes for vanddamp? Takket være vores innovative førstestokkes limningsteknologi PUResist er svaret simpelthen: ingenting!

PUResist sikrer fremragende kvalitetsegenskaber: Kanterne på vores køkkenmøbler er vandafvisende, modstandsdygtige og har en fremragende optik på grund af den usynlige fuge.

Og limningen? Fri for formaldehyd og opløsningsmidler!

PUResist betyder

- beskyttelse mod fugtindtrængen, f.eks. i madlavnings- og vaskområdet
- stærkere binding mellem træet og kanten
- fremragende optik på grund af den usynlige fuge
- bedste kvalitetsegenskaber ved alle kanter

PUResist og PURemission: Sikkerhed hele vejen igennem for vores køkkener og for dig.

WE ARE CERTIFIED

SOMOS EXCELENTES | SIAMO CERTIFICATI | VI LIGGER I SPIDSEN



First manufacturer of climate-neutral kitchen furniture with positive CO₂ balance according to the comprehensive CFP study. | Primer fabricante de muebles de cocina clima-neutral con un balance de CO₂ positivo según el estudio de la PPC. | Primo produttore di cucine componibili a impatto neutrale sul clima con bilancio CO₂ positivo come da studio CFP. | Første producent af klimaneutrale køkkenelementer med en positiv CO₂-balance ifølge CFP-undersøgelser.



Awards for our climate-neutral production
Premios por nuestra producción neutral en el clima
Cetrificazioni della nostra produzione a impatto neutrale sul clima
Priser for vores klimaneutrale produktion

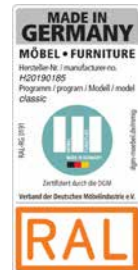

Geographical Indication of Origin "Furniture Made in Germany"
Signo de Garantía de Origen Geográfico "Muebles hechos en Alemania"
Indicazione di origine certificata "Mobili Made in Germany"
Geografisk oprindelsesgarantimærke "Möbel Made in Germany"



Awards for healthy living furniture
Premios para Muebles Saludables
Certificazione dei mobili per l'abitare sano
Priser for sunde møbler



We promote sustainable forest management
Promovemos la gestión forestal sostenible
Noi incoraggiamo la gestione sostenibile delle foreste
Vi fremmer bæredygtig skovforvaltning



Awards for our formaldehyde-reduced furniture
Premios por nuestro muebles reducidos de formaldehído
Certificazione per i nostri mobili con minima emissione di formaldeide
Priser for vores formaldehydreducerede møbler



Certified energy management system | Certificado de gestión energética |
Sistema di gestione energetica certificato | Certificeret energistyringssystem



Certified environmental management system | Gestión ambiental certificado |
Sistema di gestione ambientale certificato | Certificeret miljøstyringssystem



Tested safety of all kitchen furniture | Seguridad probada de la gama de muebles de cocina |
Sicurezza della gamma di prodotto testata | Gennemprøvet sikkerhed inden for køkkenelementprogrammet



We reserve the right to alter sizes and specification of goods without notice and are not liable for printing errors. This catalogue supercedes previous catalogues.

Reservado el derecho de modificaciones en el programa, material, modelo y medidas. Todos los ejemplos de instalación se entienden sin compromiso. Nos reservamos el derecho de notificar las erratas de imprenta. El presente catálogo invalida a todos los demás publicados hasta ahora.

Con riserva di modifiche riguardanti programma, materiali, esecuzione, dimensioni. Gli esempi di arredamento mostrati non sono impegnativi. Con riserva di correzione di eventuali errori di stampa. La pubblicazione del presente catalogo annulla tutti i cataloghi precedenti.

Forbehold for ændringer i programmet, materialet, udførelsen og målene. Alle indretningseksempler er uden forbindende. Forbehold for trykfejl. Med udgivelsen af dette katalog er alle foregående udgaver ugyldige.

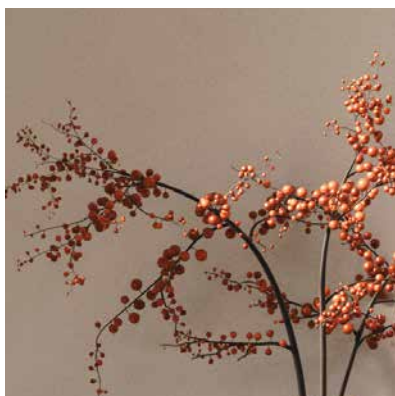

The kitchen is the heart of our homes.
These kitchens are created with pronounced
attention to details and a great devotion to
precision.

La cocina está en el corazón de la casa.
Nuestras cocinas son creadas con mucho
amor a los detalles y gran dedicación a la
precisión.

La cucina è il cuore della casa. È con l'amore
per il dettaglio e la mania della precisione che
nascono le nostre cucine

Køkkenet er hjertet i huset. Vores køkkener
skabes med stor omhu og kærlighed til
detaljen.

online version



Printed in Germany 08/2020

Art.-Nr. JL-B-21