

# KITCHEN FORUM

Foro sobre cocinas | Forum cucine | Køkken forum

# 2021



# PHILOSOPHY

Kitchens to fall in love with. Elegant and charismatic, you will experience a kitchen collection in a class of its own. Sophisticated kitchen solutions with great sensuality and an outstanding design. We only use the best ingredients – the finest materials, innovative technology and clever details. The result is well thought-out kitchen furniture with a clear concept, aesthetic forms and imaginative functions. A special room setting for cooking, living and enjoying life.



## Filosofía

Cocinas que le enamorarán. Descubra una colección de cocinas con elegancia, encanto y la máxima calidad. Soluciones de cocina sofisticadas con una gran experiencia sensorial y un diseño sobresaliente. Solo utilizamos lo mejor del mercado: los mejores materiales, tecnología innovadora y detalles inteligentes. El resultado son muebles de cocina bien meditados con un concepto claro, diseños estéticos y funciones innovadoras. Un escenario ideal para cocinar, vivir y disfrutar.

## Filosofia

Cucine di cui innamorarsi. Scoprite una collezione di cucine di alta classe, elegante e carismatica. Sofisticata soluzioni di grande sensualità e dal design d'eccezione. Per questo utilizziamo solo i migliori ingredienti, i migliori materiali, la tecnologia più innovativa e dettagli intelligenti. Il risultato sono soluzioni ben studiate, dal concetto chiaro, dalle forme estetiche e dalle funzioni piene di idee. Una scenografia davvero speciale per cucinare, vivere e divertirsi.

## Filosofi

Køkkener man elsker. Elegante og karismatiske oplevelser. Det er vores verdensklasse køkkenkollektion. Udtryksfulde køkkensløsninger med stor passion og fremragende design. Der anvender vi kun de bedste materialer, innovativ teknik og kloge detaljer. Oplevelsen er gennemtænkte køkkener med et klart koncept, æstetisk form og iderige funktioner. En særlig rumoplevelse til at kokerere, leve og nyde.



# MODERNITY

Modernidad | Modernità | Moderne

16 **AV 2045 | AV 7070**

Grey marble | Copper  
Mármol gris | Cobre  
Marmo grigio | Rame  
Marmor grå | Kobber

22 **AV 6000**

Black  
Negro  
Nero  
Sort

26 **AV 2065 | AV 1098**

Crystal white | Okobo coffee brown  
Blanco cristalino | Okobo café marrón  
Bianco cristallo | Okobo caffè  
Krystal Hvid | Okobo Brun

30 **AV 2045 | AV 4030**

Dark marble | Polar white  
Mármol oscuro | Blanco polar  
Marmo scuro | Bianco polare  
Mørk Marmor | Polarthvid

34 **AV 2130 | AV 1098**

Pearl grey | Okobo black grey  
Lava gris | Okobo negro gris  
Grigio lava | Okobo grigio-nero  
Perlegrå | Okobo sortgrå

36 **AV 8000**

Iron Grey  
Iron Grey  
Iron Grey  
Iron Grey

38 **AV 1097 | AV 6000**

Sand vintage oak | Velvet blue  
Roble envejecido arena | Azul sedamate  
Rovere antico sabbia | Blu velluto  
Sand Vintage Eg | Fløjlsblå

42 **AV 7030 | AV 7070 GL**

Black Star | Industrial steel  
Black Star | Acero industrial  
Black Star | Acciaio industrial  
Black Star | Industrielstål

48 **AV 6084 | AV 7070**

Volcano oak | Industrial steel  
Roble volcán | Acero industrial  
Rovere vulcano | Acciaio industrial  
Vulkan Eg | Industrielstål

# HANDLELESS

Sin tiradores | Senza maniglie | Grebsløøs

52 **AV 2135 GL | AV 7070 GL**

Graphite | Copper  
Grafito | Cobre  
Grafite | Rame  
Grafit | Kobber

54 **AV 1099 | AV 2130**

Walnut | Graphite  
Nogal | Grafito  
Noce | Grafite  
Valnød | Grafit

58 **AV 2130 GL**

White  
Blanco  
Bianco  
Hvid

62 **AV 6080 GL | AV 6000**

Walnut | RAL 5000 / 5014 / 7001  
Nogal | RAL 5000 / 5014 / 7001  
Noce | RAL 5000 / 5014 / 7001  
Valnød | RAL 5000 / 5014 / 7001

70 **AV 2065**

Crystal white  
Blanco cristalino  
Bianco cristallo  
Krystal Hvid

72 **AV 6082 GL | AV 4030 GL**

Natural wild oak | Crystal white  
Roble silvestre natural | Blanco cristalino  
Chêne sauvage naturel | Bianco cristallo  
Rovere selvatico naturale | Krystal Hvid

76 **AV 2135 GL**

Crystal white  
Blanco cristalino  
Bianco cristallo  
Krystal Hvid

80 **AV 6055 GL**

Taupe  
Satén  
Satin  
Satin

# MODERN COUNTRY

Modern Country | Modern Country |

Modern Country

86 **AV 6055 | AV 6055 GL**

RAL 6003 | RAL 1013  
RAL 6003 | RAL 1013  
RAL 6003 | RAL 1013  
RAL 6003 | RAL 1013

90 **AV 6084 GL | AV 7070**

Smoked oak | Industrial steel  
Roble ahumado | Acero industrial  
Rovere bruciato | Acciaio industrial  
Røget Eg | Industrielstål

94 **AV 6035**

Black  
Negro  
Nero  
Sort

100 **AV 3030**

White  
Blanco  
Bianco  
Hvid

# DETAILS

Detalles | Dettagli | Detaljer

106 Wall unit SlightLift | Glass roller shutter cabinet  
Armario alto SlightLift | Armario con persiana de cristal  
Pensile SlightLift | Mobile con serrandina in vetro  
SlightLift | Jalousiskabet

108 Cabinet philosophy  
Filosofía del cuerpo  
Filosofia del corpo  
Standardkorpus – oversigt

116 Pull-outs | Base units  
Gavetas | Armarios bajos  
Estraibili | Basi  
Udtræk | Underskabe

120 Interior organisation system  
Organización interior  
Sistema di organizzazione interno  
Indretning

125 Extras  
Extras  
Optionale  
Options

132 Front overview  
Frentes – Visión de conjunto  
Elenco modelli  
Fronter – oversigt

138 Worktops  
Encimeras  
Piani di lavoro  
Bordplader

141 Handles  
Tiradores  
Maniglie  
Greb

144 PURemission | PUResist  
PURemission | PUResist  
PURemission | PUResist  
PURemission | PUResist

# KITCHEN CONCEPT 3.0

With the Kitchen concept 3.0 you get high quality kitchen furniture in a special overall package. For you, this means a beautiful kitchen of outstanding quality as a complete package on an attractive level. Fulfil your personal kitchen wishes now. Discover extraordinary lacquer and wood expertise, perfect ergonomics and a special light variety for a completely new kitchen experience. And because the inner values are just as important, we also offer you some innovations for those.



## Concepto de cocina 3.0

Con el concepto de cocina 3.0, conseguimos muebles de cocina de alta calidad en un paquete completo especial. Esto quiere decir que usted obtendrá una cocina bonita de calidad excepcional a un precio atractivo. Podemos cumplir todos sus deseos para que la cocina de sus sueños se haga realidad. Descubra nuestros acabados de laca y de madera, una perfecta ergonomía y una especial variación de la luz para una experiencia de cocina completamente innovadora. Y como la calidad interior también es muy importante, tenemos muchas novedades que despertarán su interés.

## La cucina 3.0

Con il format della cucina 3.0 è possibile avere mobili di alta qualità in uno speciale pacchetto completo. Per voi significa una bella cucina di eccezionale qualità ad un prezzo davvero attraente. Così potete soddisfare subito i vostri desideri personali in cucina. Scoprite la nostra straordinaria competenza in fatto di laccatura e di legni, la perfetta ergonomía, le particolari variazioni di luce, per un'esperienza in cucina nuova ed unica. E dal momento che i valori interiori non sono meno importanti, anche in questo siamo in grado di proporre tante novità.

## Køkkenkoncept 3.0

Med Køkkenkoncept 3.0 får du et højkvalitetskøkken i en særlig samlet pakke. Det betyder for dig, at du får et billedskønt køkken i fremragende kvalitet som en samlet pakke på et meget højt niveau. Det opfylder således dine personlige køkkenønsker. Opdag en usædvanlig lak og trækvalitet, en perfekt ergonomi såvel som en særlig lysvariant der giver en helt ny køkkenoplevelse. Og da den indre værdi også er vigtigt, byder vi også her på nogle nyheder.



# Kitchen concept 3.0

Attractive appearance, top quality and a huge variety. Design the kitchen that fits your lifestyle perfectly. Accurate, distinguished, charming, extraordinary – be sure to find your personal dream kitchen here.

## Concepto de cocina 3.0

Diseño interesante, máxima calidad y una gran variedad. Diseñe una cocina que se adapte perfectamente a su vida. Precisión, elegancia, encanto, excepcionalidad: le garantizamos que conseguiremos la cocina de sus sueños.

## La cucina 3.0

Estetica attraente, alta qualità e una grande varietà. Progettate la cucina che si adatta perfettamente alla vostra vita. Accurata, raffinata, affascinante, straordinaria: qui troverete sicuramente la cucina dei vostri sogni.

## Køkkenkoncept 3.0

Attraktivt look, topkvalitet og en stor variation. Form dit køkken, så det passer perfekt til dit liv. Akkurat, ædel, charmerende, usædvanlig- her finder du garanteret dit personlige drømmekøkken.

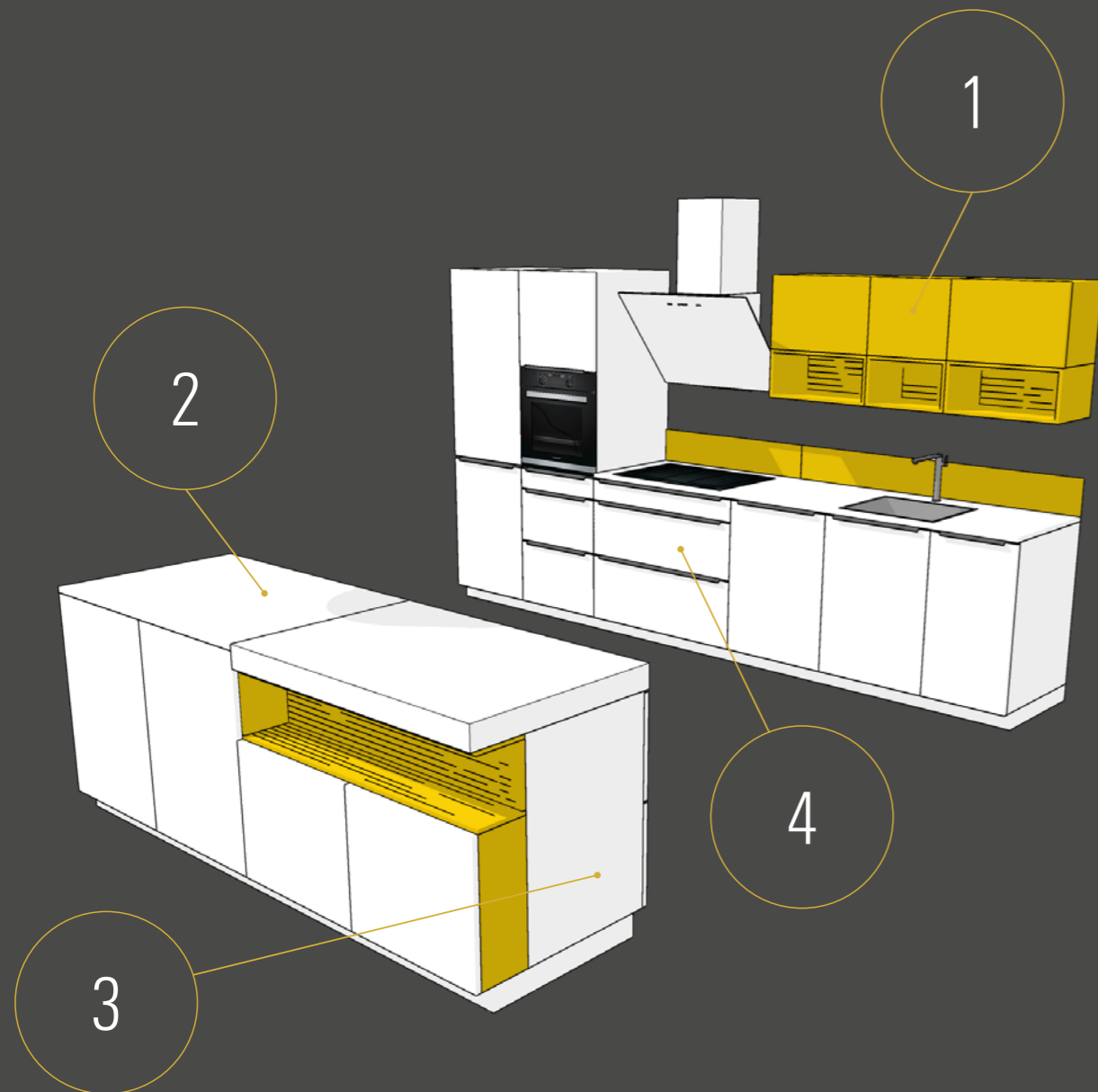

LACQUER CONCEPT  
CONCEPTO DE LACA  
LACCATURA DI QUALITÀ  
LAKKVALITET

1

Simply choose your favourite colours and make your kitchen absolutely unique.

Elija sus colores favoritos y diseñe una cocina única en la que disfrutar la vida.

Basta scegliere i colori preferiti per rendere la vostra vita in cucina assolutamente unica.

Vælg let din yndlingsfarve og gør dit køkkenliv unikt.

CARCASE  
ARMAZÓN  
SCOCCA  
KORPUS

3

Our 3 different carcass colours, each of them with the same inside and outside colour, form the perfect foundation for many combination options.

Con 3 colores de cuerpo diferentes tanto para el exterior como para el interior, tendrá la base perfecta para todas las combinaciones posibles.

3 diversi colori della scocca con l'interno e l'esterno in tinta sono la base perfetta per ogni possibile combinazione.

Med 3 forskellige korpustfarver inde og ude, har du et perfekt grundlag for samtlige kombinationsmuligheder.

ERGONOMICS  
ERGNOMIA  
ERGNOMIA  
ERGNOMI

2

Now, pleasantly back-friendly furniture. This makes your new kitchen fun.

Nuestros muebles están diseñados para que su espalda no sufra. De esta forma, podrá disfrutar totalmente de su cocina.

E finalmente dei mobili che non affaticano la schiena. Per rendere la vostra nuova cucina un davvero divertente.

Endeligt behagelige, rygskånende møbler. Så bliver dit køkken rigtig sjovt.

TECHNOLOGY  
TÉCNICA  
TECNOLOGIA  
TEKNIK

4

With great attention to detail, we have elegantly solved your requests, so that you can look forward spending time in your new kitchen every day.

Satisfacemos todas sus exigencias sin perder de vista la elegancia y el gusto por el detalle. Para que pueda disfrutar de su nueva cocina todos los días.

Con tanto amore per il dettaglio siamo in grado di soddisfare ogni vostra esigenza, con eleganza e raffinatezza. Così potete godervi ogni giorno la vostra nuova cucina.

Vi har med stor kærlighed til detaljen løst dine udfordringer på en elegant måde. Så du hver dag kan glæde dig over dit nye køkken.

**LACQUER CONCEPT**  
 CONCEPTO DE LACA  
 LACCATURA DI QUALITÀ  
 LAKKVALITET

**RAL**

- Five programs in **192 RAL colours**
- High quality UV-resistant Lacquer
- Customisable with a huge selection

**RAL**

- **Cinco** categorías en **192 colores RAL**
- Pintura de alta calidad resistente a los rayos UV
- Personalizable con un amplio abanico de opciones

**RAL**

- **Cinque** modelli in **192 colori RAL**
- Laccatura di alta qualità resistente ai raggi UV
- Personalizzabile con un'ampia gamma di colori

**RAL**

- **Fem** programmer i **192 RAL farver**
- UV-resistent lak af høj kvalitet
- Kæmpe udvalg tilpasset dig



AV 5007



AV 5035



AV 6000 + GL



AV 6035



AV 6055 + GL

**PerfectSense®**

- |                                    |                                       |                                     |                                   |
|------------------------------------|---------------------------------------|-------------------------------------|-----------------------------------|
| ■ High load-bearing capacity       | ■ Alta capacidad de carga             | ■ Elevata resistenza al carico      | ■ Høj modstandsdygtighed          |
| ■ Antibacterial surface            | ■ Superficie antibacteriana           | ■ Superficie antibatterica          | ■ Antibakterielle overflader      |
| ■ Heat and climate resistant       | ■ Resistente al calor y al mal tiempo | ■ Resistente al calore e al clima   | ■ Varme og klimabestandige        |
| ■ Completely „Made in Germany“     | ■ Fabricada totalmente en Alemania    | ■ Interamente „Made in Germany“     | ■ Fuldstændigt „Made in Germany“  |
| ■ Positive CO <sub>2</sub> balance | ■ Huella de carbono positiva          | ■ Bilancio CO <sub>2</sub> positivo | ■ Positiv CO <sub>2</sub> balance |



**AV 2130 SHINY**

Brillante | Lucido | Glansend

- Easy to clean
- Special gloss effect with great depth

- Limpieza sencilla y fácil
- Efecto brillante especial con sensación de profundidad

- Leggero e facile da pulire
- Speciale effetto lucido con effetto di profondità

- Veloce e facile da pulire
- Effetto lucido con eccezionale profondità

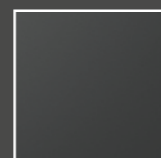

**AV 2135 MATT**

Mate | Matto | Matt

- Anti-fingerprint
- Velvety soft touch

- Acabado antihuellas
- Tacto suave y aterciopelado

- Anti-impronte
- Vellutato e morbido al tatto

- Fingeraftryk
- Fløjsblød overflader



**CRYSTAL WHITE**

BLANCO CRISTALINO  
 BIANCO CRISTALLO  
 KRYSTALHVID



**LIGHT GREY**

GRIS LUMINOSO  
 GRIGIO CHIARO  
 LYSGRÅ



**LAVA GREY**

LAVA GRIS  
 GRIGIO LAVA  
 LAVAGRÅ

**CARCASE**

ARMAZÓN  
 SCOCCA  
 KORPUS

**Design carcase**

- High-quality and elegant
- 3 different carcase colours
- Same inside and outside
- Design and aesthetics in simple elegance
- Form the perfect basis for all possible combinations

**Diseño del armazón**

- Máxima calidad y elegancia
- 3 colores del armazón diferentes
- Tanto en el exterior como en el interior
- Diseño y estética sobrios
- Forman la base perfecta para todas las combinaciones posibles

**Scocca da design**

- Raffinata e di alta qualità
- 3 diversi colori di scocca
- Esterno in tinta con l'interno
- Design ed estetica di essenziale eleganza
- Sono la base perfetta per ogni possibile combinazione

**Design - Korpus**

- Høj kvalitet
- 3 forskellige korpusfarver
- Samme inde og ude
- Design og æstetik i enkel elegance
- Danner det perfekte grundlag for alle kombinationsmuligheder

# PERFECT GRID

## ERGONOMICS

ERGONOMÍA  
ERGONOMIA  
ERGONOMI

### 3 perfect carcass heights

- The right height for all body heights: carcass height 71.5 / 78 / 84.5 cm
- Carcass height 84.5 cm offers maximum storage space
- Particularly back-friendly

### 3 alturas del armazón perfectas

- La altura adecuada para cada persona: 71,5 / 78 / 84,5 cm de altura del armazón del mueble
- Los 84,5 cm de altura le ofrecen el máximo espacio de almacenamiento
- Diseñados para que su espalda no sufra

### 3 altezze perfette delle basi

- L'altezza giusta per ogni statura: scocca alta 71,5 / 78 / 84,5 cm
- L'altezza della scocca di 84,5 cm offre il massimo della capienza
- Particolarmente adatto per non affaticare la schiena

### 3 perfekte kropshøjder

- For hver korpusstørrelse kan man planlægge den rigtige højde til projektet: 71.5 – 78 – 84.5 cm
- Kropshøjde 84.5 cm byder på maksimal opbevaringsplads
- Særligt for ryggen er det en fordel

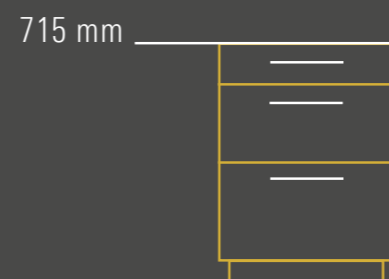
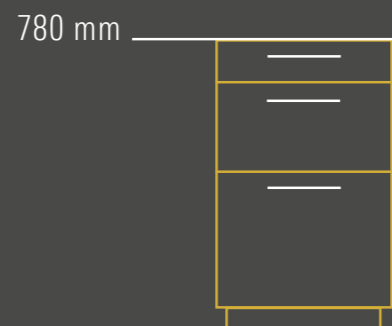
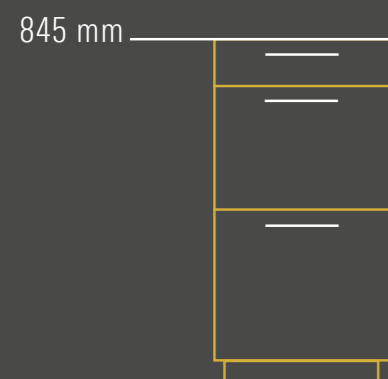

## TECHNOLOGY

TÉCNICA  
TECNOLOGIA  
TEKNIK

### SLD (Slim Line Drawer)

- Filigree 8 mm double-walled frame made of high-quality steel
- Interior colour in the new, noble titanium
- Depth effect through fine, metallic pigmentation
- Box
- Smoked glass

### SLD (Slim Line Drawer)

- Marco filigrano de 8 mm de grosor en acero de alta calidad
- Color interior con acabado de titanio moderno y elegante
- Sensación de profundidad gracias a una fina pigmentación metálica
- Extracción de cajones
- Extracción de cristal ahumado

### SLD (Slim Line Drawer)

- Sponde ultra sottili a doppia parete da 8 mm in acciaio di alta qualità
- Interni nel nuovo ed elegante look in color titanio
- Profondità di colore grazie ad una fine pigmentazione metallica
- Cestone scatolato Box
- Cestone con sponde in vetro fumé

### SLD (Slim Line Drawer)

- Fine 8 mm dobbeltsidet sarg af kvalitetsstål
- Ny tilbehørsfarve i ædel Titan
- Dybdevirkning gennem en fin metallisk pigmentering
- Box
- Røget glas

# MODERNITY

Beautiful fronts in combination with the imposing, brilliant surfaces create an exciting atmosphere. Striking shapes harmonize with soft accents and create a unique kitchen harmony. Everything fits together wonderfully. The impressive charisma accompanies the flowing transition from the kitchen to the living room furniture. This is how you achieve your personal kitchen lifestyle.

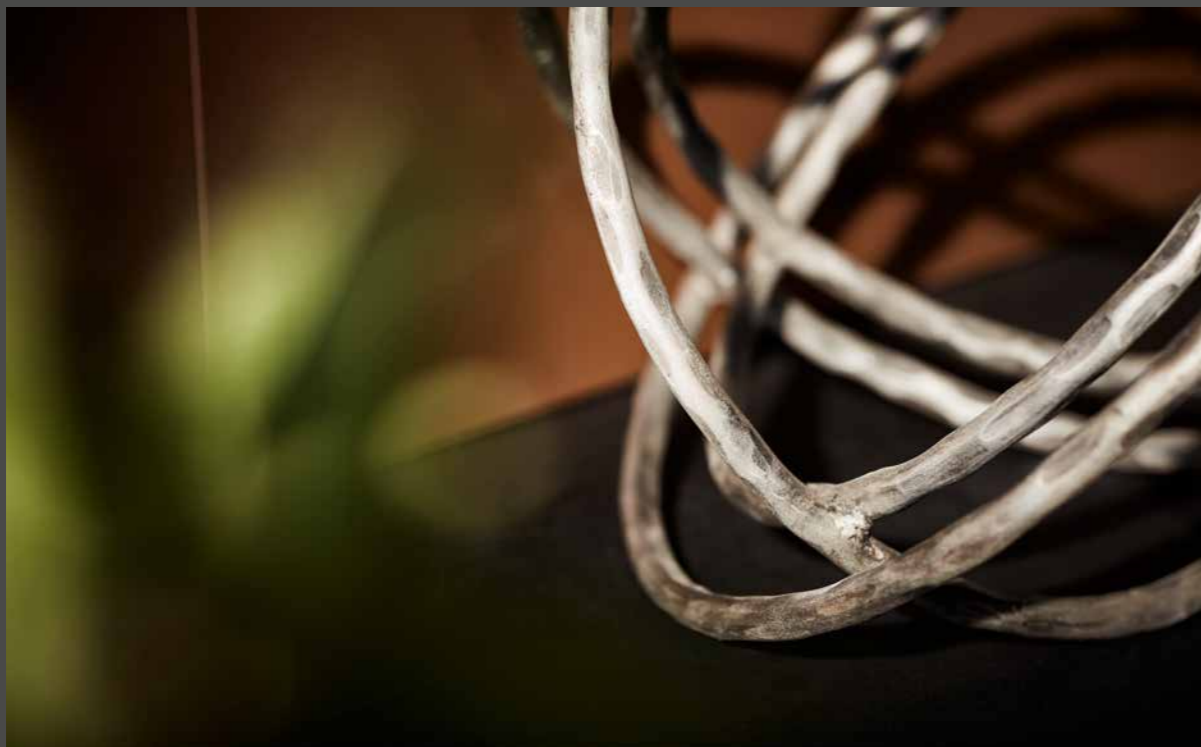

## Modernidad

La combinación de frentes bonitos con superficies elegantes y brillantes crean un resultado fascinante. Las formas llamativas combinan a la perfección con los detalles suaves y crean una cocina con una armonía única. El resultado es totalmente increíble. El llamativo diseño facilita una transición fluida de la cocina a los muebles del salón. De esta forma, su cocina también puede tener mucho estilo.

## Modernità

Le belle ante in combinazione con le superfici raffinate e brillanti creano un'atmosfera emozionante. Le forme sorprendenti armonizzano con le note morbide, creando un insieme unico in cucina. Tutto si incastra meravigliosamente. Il grande fascino accompagna il fluido passaggio dalla cucina alla zona living. Questo è vivere con stile anche in cucina.

## Moderne

Billedskønne fronter i kombination med ædle, brillante overflader i samspil med hinanden. Markante og bløde former kombineret med hinanden opbygger en ensartet harmoni. De passer bare helt fantastisk sammen. Det imponerende udtryk understreger overgangen fra køkkenmøbler til stuemøbler. Så lever man også virkelig stilfuldt i køkkenet.





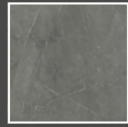

AV 2045

**Grey marble**  
Mármol gris  
Marmo grigio  
Marmor grå

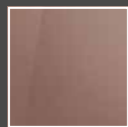

AV 7070

**Copper**  
Cobre  
Rame  
Kobber



PerfectSense®

video





## Expressive

Copper develops a special intensity, looks elegant and modern. Put your new kitchen in the spotlight with warm colour accents in combination with black or white. That way you create a pleasant, feel-good atmosphere in a natural way.

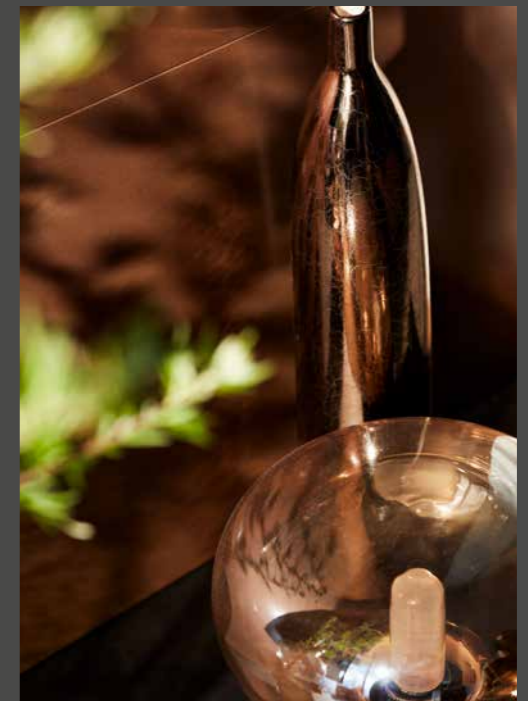

## Expresividad

El cobre desarrolla una intensidad especial y tiene un acabado elegante y moderno. Dale un toque único a su nueva cocina con algunos detalles en colores cálidos combinados con blanco o negro. Esta técnica crea una atmósfera agradable y natural que le invita a disfrutar de su hogar.

## Espressività

Il rame sprigiona una particolare intensità, raffinatezza e modernità. Mettete sapientemente in scena la vostra nuova cucina con note di colore calde in combinazione con il bianco o il nero. In questo modo è possibile creare una piacevole atmosfera di benessere in modo naturale.

## Udtryksfuld

Kobber indeholder en særlig intensitet, er ædel og moderne. Sæt dit nye køkken i scene med varme farvekombinationer med sort eller hvid. Så skaber du en hjemlig atmosfære.



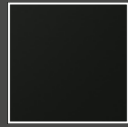

AV 6000

**Black**  
Negro  
Nero  
Sort





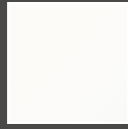

AV 2065

**Crystal white**  
Blanco cristalino  
Bianco cristallo  
Krystal Hvid



AV 1098

**Okobo coffee brown**  
Okobo café marrón  
Okobo caffè  
Okobo Brun







AV 2045

**Dark marble**  
Mármol oscuro  
Marmo scuro  
Mørk Marmor



AV 4030

**Polar white**  
Blanco polar  
Bianco polare  
Polarhvid

PerfectSense®









AV 2130

**Pearl grey**  
Gris perla  
Grigio lava  
Perlegrå



AV 1098

**Okobo black grey**  
Okobo negro gris  
Okobo grigio-nero  
Okobo sortgrå



PerfectSense®





# AV 8000

**Iron Grey**  
Iron Grey  
Iron Grey  
Iron Grey





AV 1097

**Sand vintage oak**  
Roble envejecido arena  
Rovere antico sabbia  
Sand Vintage Eg

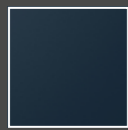

AV 6000

**Velvet blue**  
Azul seda  
Blu velluto  
Fløjlsblå





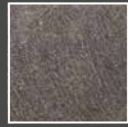

# AV 7030

**Black Star**  
Black Star  
Black Star  
Black Star



# AV 7070 GL

**Industrial steel**  
Acero industrial  
Acciaio industrial  
Industriestål



video











AV 6084

**Volcano oak**  
Roble volcán  
Rovere vulcano  
Vulkan Eg



AV 7070

**Industrial steel**  
Acero industrial  
Acciaio industrial  
Industriestål



# HANDLELESS

Puristic and fascinating – the handleless kitchen. Depending on the design, the channel handles are either hidden or specially highlighted with LED lighting. The Tipmatic Softclose technology ensures that pull-outs and drawers slide magically in and out with a simple push. No handle disturbs the charisma of the impressive fronts.



## Sin tiradores

Sencillas y fascinantes: las cocinas sin tiradores. Según el modelo, los tiradores están instalados de forma discreta en el cuerpo o están especialmente resaltados por iluminación LED. La tecnología Tipmatic Softclose le garantiza que las gavetas y cajones se abran con un simple toque, como por arte de magia. Así, ningún tirador se interpone en el diseño elegante de los frentes.

## Senza maniglie

Stile purista e attraente: la cucina senza maniglie. A seconda delle esigenze di design, la gola possono restare piacevolmente discrete o vengono messe in scena grazie all'illuminazione con LED. La tecnologia Tipmatic Softclose fa sì che cestoni e cassetti si aprano come per magia con una semplice pressione. E nessuna maniglia interrompe l'elegante scorrere delle superfici.

## Grebsløs

Rent og attraktivt – det grebsløse køkken. Grebslisten kan enten være diskret eller sættes ekstra i scene ved hjælp af LED-belysningen. Tipmatic Softclose-teknikken sørger for, at udtræk og skuffer nærmest magisk åbner sig ved et enkelt tryk. Her forstyrrer intet greb udseendet af fronten.





AV 2135 GL

**Graphite**

- Grafito
- Grafite
- Grafit

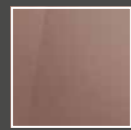

AV 7070 GL

**Copper**

- Cobre
- Rame
- Kobber

oneLINE

PerfectSense®





AV 1099

**Walnut**  
Nogal  
Noce  
Valnød



AV 2130

**Graphite**  
Grfito  
Grafite  
Grafit



PerfectSense®







AV 2130 GL

White  
Blanco  
Bianco  
Hvid



oneLINE

PerfectSense®





## oneLINE



### oneLine: the special design

The clarity of this fantastic kitchen is expressed in straightforwardness, concentration on the essentials and precision. Uniform lines due to grid heights with a minimal joint pattern (4 mm) between the lower drawers and pull-outs. With oneLine you will find an extraordinarily concise design that you can enjoy even in special installation settings.

### oneLine: un diseño especial

La sencillez de esta fantástica cocina se expresa principalmente en líneas rectas, concentración en lo esencial y precisión. Líneas uniformes debido a las alturas de la rejilla con un patrón de unión mínimo (4 mm) entre los cajones inferiores y las gavetas.

### oneLine: un design speciale

La chiarezza di questa fantastica composizione si esprime in linee rette, concentrando sull'essenziale e sulla precisione. Le linee sono uniformi grazie alle altezze modulari ed alle fughe di appena 4 mm tra cassetti e cestoni. Con OneLine troverete un design straordinariamente sintetico ed essenziale del quale potrete godere anche nelle soluzioni più particolari.

### oneLine: det særlige design

Dette fantastiske køkkens udtryk bliver fremhævet ved enkelthed, fokus på det væsentlige og præcision. En konsekvent linjeføring opnås ved minimal afstand (4 mm) mellem skufferne. Her får du et stramt design, som også kan benyttes ved særlige installationsbetingelser.

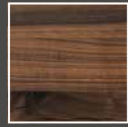

AV 6080 GL

**Walnut**  
Nogal  
Noce  
Valnød

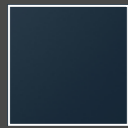

AV 6000 GL

**RAL 5000 / 5014 / 7001**  
RAL 5000 / 5014 / 7001  
RAL 5000 / 5014 / 7001







### As unique as your life

Design your breathtaking unique kitchen with RAL colours – absolutely breathtaking. Discover completely new options for your personal dream kitchen. Either wood character with colour harmonies or special contrasts with tone-on-tone compositions. We make your kitchen just as unique as you are, to your personal taste.



### Única, como la vida

Diseñe su nueva cocina de forma totalmente personalizada con colores RAL: totalmente impresionante. Descubra posibilidades completamente nuevas para la cocina de sus sueños. Madera con armonía cromática o contrastes llamativos con composiciones a tono. En el libro de los gustos no hay nada escrito: hacemos que su cocina sea tan maravillosa como usted.

### Unico, come la vostra vita

Progettate la vostra nuova cucina in modo completamente personalizzato con colori RAL – assolutamente mozzafiato. Scoprite possibilità completamente nuove per la vostra personale cucina da sogno. Che si tratti di carattere ligneo con armonie cromatiche o di contrasti forti con composizioni tono su tono. Proprio come i vostri gusti, facciamo la vostra cucina – meravigliosa come lo siete voi.

### Enestående, som dit liv

Individualiser dit nye køkken med RAL-farver – absolut betagende. Opdag de nye muligheder for dit personlige drømmekøkken. Uanset om det er træstrukturer med farvekombinationer eller kontraster med tone i tone, fremstiller vi det nøjagtigt til din smag, - fantastisk som dig.







# AV 2065

**Crystal white**  
Blanco cristalino  
Bianco cristallo  
Krystal Hvid





## AV 6082 GL

**Natural wild oak**  
Roble silvestre natural  
Chêne sauvage naturel  
Naturlig Vild Eg

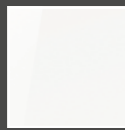

## AV 4030 GL

**Crystal white**  
Blanco cristalino  
Bianco cristallo  
Krystal Hvid





### This room can do everything

With the right equipment, a perfectly integrated utility room becomes a real centre of excellence. Ergonomically well thought-out and with lots of useful modules, everything runs almost automatically – laundry included.

### Espacio para todo

Con el equipo adecuado, un lavadero perfectamente integrado puede convertirse en un verdadero centro de rendimiento. Gracias a su ergonomía meditada y a la gran variedad de módulos útiles, todo funciona a la perfección: incluso la lavandería.

### Questo ambiente può fare tutto

Con l'attrezzatura giusta, un ripostiglio perfettamente integrato ed organizzato può diventare una vera e propria piattaforma di servizi. Ergonomicamente ben studiato e con molti moduli utili, tutto funziona come un orologio di precisione, compreso il bucato.

### Dette rum kan alt

Med det rigtige udstyr bliver bryggerset til et perfekt integreret oplevelsescenter. Ergonomisk gennemtænkt med forskellige nyttige moduler kører det hele af sig selv inklusiv vask.



# AV 2135 GL

**Crystal white**  
Blanco cristalino  
Bianco cristallo  
Krystal Hvid



oneLINE

PerfectSense®









AV 6055 GL

Taupe  
Satén  
Satin  
Satin



oneLINE





### Little helpers within reach

This is smart and looks great. With the functional frame, you will always have the most important cooking equipment at hand. Whether pepper, salt, cooking oil, opener or scissors ... everything has its spot here and is quickly ready for use. This is how ingenious usefulness can be.



oneLINE

### Utensilios: siempre a mano

Es una idea ingeniosa y que resulta muy elegante. Con este marco funcional, siempre tendrá sus utensilios de cocina más importantes a mano. Pimienta, sal, aceite, abridor o tijeras... todo tiene su lugar y están siempre a mano. Un diseño genial y muy útil.

### Piccoli aiutanti, sempre a portata di mano

È intelligente e ha un'estetica fantastica. Con il telaio funzionale i più importanti utensili per la cucina sono sempre a portata di mano. Che si tratti di pepe, sale, olio da cucina, apriscatole o forbici... tutto qui ha il suo posto ed è rapidamente pronto all'uso. Quando l'ingegnoso sa essere anche utile.

### En lille hjælper indenfor rækkevidde

Den er smart og ser godt ud. Med funktionsrammen har du altid alle madlavningsingredienser i nærheden. Uanset om det er peber, salt, spiseolie, oplukker eller saks, har alt sin plads og er klar til brug. Så genialt kan noget nyttigt være.

# MODERN COUNTRY

Between trees and meadows, with the scent of flowers and herbs. Discover a new country house style. "Modern Country" offers you not only a tasteful look but also the latest innovations. This kitchen invites you to feast, to taste and to relax. Thanks to the extensive selection of colours, materials and accessories, you can determine the rural appearance of your new kitchen according to your personal wishes. Modern country life in its most beautiful way.



## Modern Country

Un hogar entre los árboles y los prados, con el aroma de las flores y de las hierbas. Descubra un nuevo estilo de casa de campo. «Modern Country» le ofrece un diseño con mucho estilo y las innovaciones más modernas. Esta cocina invita a darse un festín, a saborear y a sentirse bien. Gracias a la amplia gama de colores, materiales y accesorios, puede elegir un diseño rústico para su nueva cocina, según su gusto personal. La vida moderna en el campo en su forma más bonita.

## Modern Country

Tra alberi e prati, con il profumo dei fiori e delle erbe aromatiche. Scoprite il nuovo romantico stile country. „Modern Country“ si distingue non solo per look raffinato ma anche per l'innovazione. Questa cucina vi invita a godere dei piaceri della tavola e a sentirvi bene. Grazie all'ampia scelta di colori, materiali e accessori, potrete comporre la vostra nuova cucina come più vi piace, secondo i vostri personalissimi gusti. La moderna vita di campagna nella sua forma più bella.

## Modern Country

Mellem træer og græs, med duften af blomster og urter. Du opdager en ny landstedsstil. "Modern Country" tilbyder udover det smagsfulde udseende også moderne innovation. Dette køkken indbyder til fest og hjemlig hygge. Takket være det store farveudvalg, materialer og tilbehør kan du opnå det landlige udseende i dit nye køkken. Moderne landliv i sin skønneste form.



AV 6055

RAL 6003  
RAL 6003  
RAL 6003  
RAL 6003

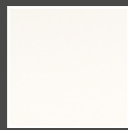

AV 6055 GL

RAL 1013  
RAL 1013  
RAL 1013  
RAL 1013



## Island solutions

Today's kitchen is a communication centre and a popular place to stay with your loved ones. Therefore you obviously want to create the most beautiful and well thought out kitchen design. Island solutions create more space, create more freedom of movement and support communication. In addition, your new kitchen looks particularly impressive. This is how you let your space unfold.



## Soluciones de isla

Hoy en día, la cocina es un centro de comunicación y el mejor lugar para reunir a los seres queridos. ¿Hay algo mejor que diseñar cuidadosamente una cocina y elegir el estilo que más le guste? Las soluciones de isla le proporcionan más espacio, le ofrecen más libertad de movimiento y favorecen la comunicación. Su nueva cocina será totalmente impresionante. De esta manera, todo tiene su espacio.

## Soluzioni ad isola

La cucina oggi è un centro di comunicazione dove i vostri cari amano soggiornare. Cosa c'è di più naturale che progettare con cura una cucina e scegliere il design più bello. Le composizioni con isola creano più spazio, danno più libertà di movimento e incoraggiano la comunicazione. E la vostra nuova cucina guadagna anche un look accattivante. Così si dà allo spazio il giusto ambiente.

## Øløsning

Køkkenet er i dag kommunikationscentrum og et elsket opholdsrum for dit liv. Hvorfor ikke planlægge køkkenet omhyggeligt og vælge det flotteste design? Øløsningen giver mere plads, mere bevægelsesfrihed og fremmer kommunikationen. Derudover ser dit nye køkken særlig udtrykfuldt ud. Det er sådan, du udnytter pladsen bedst i rummet.





## AV 6084 GL

**Smoked oak**  
Roble ahumado  
Rovere bruciato  
Røget Eg



## AV 7070

**Industrial steel**  
Acero industrial  
Acciaio industrial  
Industrieltål







AV 6035

**Black**  
Negro  
Nero  
Sort



video







## Exclusive shelving systems

Here everything shines and sparkles. Design modern shelving systems according to your desire. The shelves go with your favorite wine, with your favorite flower or your favorite decoration piece. This is how designing your kitchen gets even more fun. Give it your own personal signature. Admirable and unique.



## Sistemas de estantes exclusivos

¡Una apuesta segura! Diseñe sistemas modernos de estantes según sus requisitos. Para sus vinos favoritos, para colocar sus flores preferidas o a juego con la decoración de la casa. Cocinar será muy divertido y su cocina tendrá su toque personal. Increíble y única.

## Scaffali esclusivi

Qui tutto fa a gara per splendere di più. Progettate il sistema di scaffali secondo i vostri gusti, abbinato al vino preferito, abbinato al fiore preferito, abbinato alla decorazione preferita. Questo rende la cucina divertente e le dà un tocco personale. Unica e da ammirare.

## Eksklusive reolsystemer

Her er alt på spil. Design det moderne reolsystem helt efter dine ønsker. Velegnet til yndlingsvinen, velegnet til yndlingsblomsterne, velegnet til yndlingsdekorationen. Sådan bliver køkkenet sjovt og personligt. Beundringsværdigt og unikt.



### Special solutions

A lot of attention to detail. The multifaceted solutions make these kitchen elements so valuable, because they are practical and special at the same time. Like this, every treasure has its place.

### Soluciones especiales

Nos centramos en el gusto por los detalles. Las soluciones versátiles hacen que estos elementos de cocina sean muy valiosos. Porque son prácticos y originales. Todo tiene su lugar en la cocina.

### Soluzioni speciali

Anche qui c'è molto amore per il dettaglio. Le molteplici soluzioni rendono questi elementi della cucina davvero preziosi. Perché sono allo stesso tempo pratici e originali. Così ogni cosa ha il suo posto.

### Særlige løsninger

Her ligger der igen stor kærlighed til detaljen. De mangeartede løsninger gør disse køkkenelementer meget værdifulde. Så er du samtidig både praktisk og original.



AV 3030

White  
Blanco  
Bianco  
Hvid







# DETAILS

Tidiness, clarity, functionality and ergonomic design. Everything has been well thought out to make your life a little easier and more enjoyable. Multifaceted equipment options and intricate details make your new kitchen your favourite place. From the beautiful design to the sophisticated technology. From the damping hinge to climate neutral production. More and more ideas. Super practical and ingeniously solved. You will have a lot of fun with your new kitchen.



## Detalles

Orden, claridad, funcionalidad y diseño ergonómico. Hemos pensado en todo lo necesario para que su vida sea un poco más fácil y agradable. Las múltiples opciones de equipamiento y los detalles de calidad harán que su nueva cocina se convierta en su lugar favorito de la casa. Desde un diseño increíblemente bonito hasta la tecnología más sofisticada. Desde las bisagras amortiguadas hasta la fabricación climáticamente neutra. Tenemos un sinfín de ideas. Soluciones prácticas y geniales. Estamos seguros de que su nueva cocina le hará muy feliz.

## Dettagli

Ordine, chiarezza, funzionalità e design ergonomico. Tutto qui è stato pensato per rendere la vita un po' più facile e piacevole. Le molteplici opzioni di accessori e dettagli di qualità rendono la vostra nuova cucina sicuramente il vostro posto preferito. Dall'alto design alla tecnologia ben studiata. Dalle cerniere rallentate alla produzione ad impatto zero sul clima. Sempre più idee. Super pratica e soluzioni ingegnose. Così con la vostra nuova cucina vi divertirte un mondo.

## Detaljer

Orden, overblik, funktionalitet og ergonomisk design. Her er der tænkt på alt, der gør dit liv lettere og mere behageligt. Mange udstyrsmuligheder og værdifulde detaljer gør dit nye køkken til et ægte yndlingssted. Fra vidunderlig design til gennemtænkt teknik. Fra dæmpede hængsler til klimaneutral fremstilling. Altid flere ideer. Super praktisk og genialt løst. Så har du stor glæde af dit nye køkken.

# SlightLift

↑ slide ↖ lift ☀ lights on



reddot award 2018  
honourable mention



SlightLift: When exceptional looks meet innovative technology

The SlightLift wall unit impresses with its unusual appearance in combination with atmospheric lighting technology. Whether it is used as a closed wall unit or open as a decorative shelf: it is always an eye-catcher.

The lower front with its handle strip can be slid vertically behind the upper one. Here the integrated lighting control unit can vary the lighting scenario between pleasing ambient lighting and functional light.

The word creation SlightLift is a combination of the words „Slide“, „Light“ and „Lift“ and describes the essential wall unit features: sliders, flaps and intelligent lighting control.

SlightLift is distinguished both with the „Iconic Award 2018: Innovative Interior“ as well as the internationally-recognised quality and design award „Red Dot Award 2018 Honourable Mention“.

SlightLift: innovazione tecnologica ed estetica, mano nella mano

Il pensile SlightLift, con la sua straordinaria estetica unita a suggestivi effetti di luce offre tanti argomenti per farsi scegliere: come pensile chiuso o elemento a giorno come oggetto d'arredo, sa catturare sempre lo sguardo di tutti.

L'anta inferiore, dotata di un sottile profilo come maniglia, scorre dolcemente in verticale dietro all'anta superiore. La luce integrata può essere regolata in modo da cambiare l'atmosfera dell'ambiente da confortevole a funzionale. Il nome d'arte SlightLift è una combinazione delle parole „Slide“, „Light“ e „Lift“ che sintetizzano le sue caratteristiche essenziali: movimento, chiusura e controllo intelligente della luce. SlightLift ha ottenuto il premio per l'innovazione „Iconic Award 2018: Innovative Interior“ e il riconoscimento a livello mondiale „Red Dot Award 2018 Honourable Mention“ per la qualità ed il design.

El SlightLift: un acabado único se da cita con la tecnología más puntera

El armario suspendido SlightLift convence con un diseño único que se aúna con una técnica de iluminación lograda. Ya sea de forma cerrada como armario suspendido o abierto como estantería decorativa: en cualquier de los casos llamará la atención.

El frente inferior con listón para agarrar se puede deslizar, de forma vertical, hacia detrás de la parte superior. Mientras que la unidad de control de la iluminación integrada cambia la iluminación de un nivel más suave y ambientado a una iluminación funcional y viceversa.

El nombre SlightLift se compone de los términos ingleses «Slide», «Light» y «Lift» que describen las características principales de este mueble: deslizable, abatible y con un control de iluminación inteligente.

El SlightLift ha sido galardonado tanto con el premio a la innovación «Iconic Award 2018: Innovative Interior» como con el distintivo de calidad y diseño de renombre internacional «Red Dot Award 2018 Honourable Mention».

SlightLift: Når unik optik møder innovativ teknik

SlightLift overskabet imponerer med en usædvanlig optik i kombination med en stemningsfyldt lysteknik. Uanset om det er som lukket overskab eller åben som en dekorativ reol: I alle tilfælde vækker det opmærksomhed.

Den nederste låge med grebliste kan skubbes lodret ind bag den øverste låge. Samtidig skifter den integrerede lysstyringsenhed lys-scenariet fra en behagelig hyggebelysning til funktionslys og tilbage igen. Kunstnavnet SlightLift er sammensat af ordene „Slide“, „Light“ og „Lift“ og dækker skabets væsentligste egenskaber: Skubbe, vippe og den intelligente lysstyring.

SlightLift vandt både innovationsprisen „Iconic Award 2018: Innovative Interior“ og den internationalt anerkendte kvalitets- og designpris „Red Dot Award 2018 Honourable Mention“.

GLASS ROLLER SHUTTER  
CABINET

ARMADI CON SERRANDINA  
IN VETRO



ARMARIO CON PERSIANA  
DE CRISTAL

GLAS RULLEJALOUSISKAB



Elegant look and excellent characteristics: the glass roller shutter cabinet has an impressive design and functionality.

Whether as a wall unit or a worktop wall unit, the glass roller shutter will be an eye-catcher in every modern kitchen.

The model, with an electrified glass shutter, ensures quiet opening and closing using the invisible touch switch on the lower lamella.

The manual version will impress with its integrated stainless-steel brushed handle and the ball-bearing cable guide roller ensures smooth and stable running.

The integrated glass cover creates a harmonious and high-quality overall appearance.

For an attractive appearance in the closed state as well as in open-look shelving.

Eleganza ed eccezionale scorrevolezza: la serrandina in vetro conquista per design e funzionalità

Come pensile o sopralzo, la serrandina in vetro è il richiamo visivo per eccellenza in qualsiasi cucina moderna.

La versione elettrificata garantisce un'apertura e una chiusura della serrandina in vetro silenziosa ed emozionante grazie all'interruttore a sensore invisibile sulla lamella inferiore.

La variante manuale conquista per il design minimalista della maniglia acciaio inox spazzolato ed allo scorrimento silenzioso e sicuro del meccanismo con cuscinetti a sfera.

La superficie in vetro crea un aspetto complessivo armonioso e di qualità. La sua estetica è sempre attraente, sia a serrandina chiusa, trasparente, sia a serrandina aperta, come scaffale a giorno.

Aspecto elegante y características de funcionamiento excelentes: el armario con persiana de cristal convence por su diseño y su función

Bien como armario superior o como sobreencimera: el armario con persiana de cristal es un auténtico atractivo en una cocina moderna en cualquiera de sus versiones.

La versión con persiana de cristal eléctrica garantiza una apertura y un cierre con sonido afectivo y silenciosos por medio del interruptor táctil invisible en la laminilla inferior. La variante manual seduce con su tirador integrado de color acero cepillado y, gracias a las guías de cable con rodamientos de bolas, garantiza una marcha suave y estable. El frente de cristal integrado, crea una apariencia general armoniosa y de gran calidad. Para disfrutar de un aspecto atractivo tanto en su discreta imagen cerrada como también con la óptica de estantería al abrirlo.

Elegant optik og fremragende funktionskarakteristik: Glasjalousiskabet imponerer med sit design og sin funktion

Både som væg- og overskab: Glasjalousiskabet er uanset udførelse altid et blikfang i det moderne køkken.

Udførelsen med elektrificeret glasjalousi garanterer støjsvag åbning og lukning med den skjulte touch-kontakt på nederste lamel. Den manuelle udgave imponerer med den integrerede grebliste i børstet rustfrit stål og giver takket være Quadro-styring en rolig og stabil løbskarakteristik. Det integrerede glaspanel skaber et overordnet harmonisk udseende i en høj kvalitet.

Har et elegant udtryk både i den clean-lukkede udgave og i den åbne reoloptik.

# CABINET PHILOSOPHY

## Cabinet Philosophy

We offer you three different carcass colors - crystal white, light grey and lava grey - in a high quality and noble finish. They form the perfect basis for all possible combinations. Due to the continuity inside and outside, the result is an outstanding elegance.

## Filosofía del armazón

De alta calidad y clase le ofrecemos tres colores diferentes del Cuerpo: blanco cristalino, gris claro y gris lava. Forman la base perfecta para todas las combinaciones posibles. Debido a la consistencia interior y exterior, el resultado es una elegancia excepcional, como de una sola pieza.

## Filosofia della scocca

Per la scocca sono disponibili tre diversi colori, eleganti e raffinati: bianco cristallo, grigio chiaro e grigio lava. Questi costituiscono la base perfetta per ogni possibile combinazione. Il coordinamento tra interno ed esterno, entrambi in tinta, crea un effetto di straordinaria eleganza, come se tutto provenisse da un'unica matrice.

## Korpusfilosofi

Vi tilbyder dig tre forskellige grundfarver af høj kvalitet og klasse – krystalhvid, lysegrå og lavagrå. De skaber det perfekte grundlag for alle tænkelige kombinationer. Takket være kontinuiteten inde og ude er resultatet en enestående elegance, der giver indtrykket af at være fremstillet i ét stykke.



## Design carcass colour

Colores de armazón de diseño

Colori della scocca da design

Designkorpus

2077

Crystal white  
Blanco cristalino  
Bianco cristallo  
Krystal Hvid

2022

Light grey  
Gris luminoso  
Grigio chiaro  
Lysgrå

2059

Lava grey  
Lava gris  
Grigio lava  
Lavagrå

## Brilliant surfaces plus impressive concept for visible carcass sides

We offer with Kitchen 3.0 an impressive concept. Visible carcass sides are no longer covered with separate kitchen formed gable ends. They are now painted directly to match the front. This allows you to benefit from attractively priced visible sides in matching colors. You will receive almost infinite color variations in matt or high gloss as well as an innovative PerfectSense surface. The special anti-fingerprint property prevents marks on the surfaces and makes them very easy to clean. The trendy, pleasant and velvety design looks good and gives it a soft touch and feel. In addition, the PerfectSense surface is resistant to light and UV, heat, climate and water vapor as well as antibacterial. Safe and perfect in all aspects.

## Superficies brillantes más impresionante concepto de costados vistos

Con la Cocina 3.0 le ofrecemos un impresionante concepto de costado visto. Los lados visibles ya no están cubiertos con costados adosados, sino que se acaban directamente para que coincidan con el frente. Esto significa que se beneficia de un precio atractivo y que coinciden con el color del frente. Se obtendrán variaciones de color casi infinitas en mate o alto brillo, así como una innovadora superficie PerfectSense. La función especial anti huellas evita las huellas dactilares en las superficies y las hace muy fáciles de cuidar. El diseño moderno, agradable y aterciopelado le invita a tocar y sentirse bien al mismo tiempo. Además, la superficie PerfectSense es resistente a la luz y a los rayos UV, resistente al calor, al aire y al agua, así como a la antibacteriana. Esto le permite estar completamente seguro.

## Superfici brillanti e una soluzione intelligente per i lati a vista

Con la cucina 3.0 proponiamo una soluzione smart per gestire il lato a vista. Non è più necessario infatti coprire i lati a vista con fianchi, ma laccarli direttamente insieme all'anta. In questo modo si hanno i lati visibili in tinta nei colori coordinati a prezzi sostenibili. È possibile scegliere una gamma pressoché infinita di colori sia opachi che lucidi o dell'innovativa superficie PerfectSense. Lo speciale trattamento delle superfici impedisce la presenza di impronte su ante e top e li rende molto facili da pulire. Il design di tendenza delle superfici, piacevole e vellutato, invita allo stesso tempo a toccarle e a sentirsi bene. Inoltre PerfectSense è resistente alla luce e ai raggi UV, al calore, agli agenti climatici e al vapore acqueo, oltre ad essere antibatterica. Insomma, sicurezza in tutto e per tutto.

## Strålende overflader plus et attraktivt sidekoncept

Med Küche 3.0 tilbyder vi dig et imponerende sidekoncept. De synlige sider beklædes ikke længere med separate køkkenpaneler men males direkte for at matche fronten. Du får fordel af attraktive priser og synlige sider, der matcher farverne. Du får næsten uendelige farvevariationer i mat eller højglans såvel som en innovativ overflade ved navn PerfectSense. En særlig teknologi forhindrer fingeraftryk på overfladerne og gør dem meget nemme at pleje. Det moderne, behagelige og fløjlsagtige design styrker interaktion og velbefindende på én gang. Derudover er PerfectSense-overfladen lys- og UV-afvisende, varme-, klima- og vanddampbestandig samt antibakteriel. Det giver tryghed!

## PerfectSense®

UV high gloss lacquer  
UV lacado alto brillo  
UV Laccato lucido brillante  
UV-højglanslakeret

UV satin lacquer  
UV laca mate satinada  
UV laccato opaco  
UV-mat lak

LD 183

Crystal white  
Blanco cristalino  
Bianco cristallo  
Krystal Hvid

LMD 507

Crystal white  
Blanco cristalino  
Bianco cristallo  
Krystal Hvid

LD 179

Polar white  
Blanco polar  
Bianco polare  
Polarhvid

LMD 500

Polar white  
Blanco polar  
Bianco polare  
Polarhvid

LD 186

White  
Blanco  
Bianco  
Hvid

LMD 508

White  
Blanco  
Bianco  
Hvid

LD 195

Taupe  
Satén  
Satin  
Satin

LMD 509

Taupe  
Satén  
Satin  
Satin

LD 200

Pearl grey  
Gris perla  
Grigio perla  
Perlegrå

LMD 510

Pearl grey  
Gris perla  
Grigio perla  
Perlegrå

LD 127

Graphite  
Grafito  
Grafite  
Graphite

LMD 511

Graphite  
Grafito  
Grafite  
Graphite

LMD 512

Black  
Negro  
Nero  
Sort



#### Top/Bottom shelf 19 mm thick

The inset shelves and also the bottom/top panels are 19 mm thick and withstand high loads.

#### Fondo/Estante superior 19 mm de grosor

No solo las baldas tienen un espesor de 19 mm, también los fondos/estante superior de armario están provistos de eso, por lo que soportan cargas muy elevadas.

#### Fondo e cielino con spessore 19 mm

Non solo i ripiani ma anche il fondo ed il cielino della scocca hanno spessore 19 mm e sono pertanto in grado di sopportare carichi elevati.

#### Top- og bundplade 19 mm tykke

Ikke blot hyldeerne, men også top og bund er 19 mm tykke og kan holde til stor belastning.

#### 35 cm carcasse depth

Extra deep upper cabinets also offer space for large bowls and pizza plates (interior depth 33 cm).

#### Profundidad del armazón 35 cm

Los armarios colgantes de gran profundidad también ofrecen espacio para grandes fuentes y platos de pizza (profundidad interior 33 cm).

#### Profondità della scocca 35 cm

I pensili molto profondi offrono spazio per grandi insalatiere e piatti da pizza (profondità interna di 33 cm).

#### Korpusdybde 35 cm

Ekstra dybe overskabe giver også plads til store skåle og pizzatallerkener (indvendig dybde 33 cm).

#### Metal shelf support with safety pin

The shelves are particularly hard-wearing and can be adjusted individually via a row of holes in the body.

#### Soporte de estantes metálico con seguro de extracción

Los suelos son sumamente resistentes y, gracias a una hilera de orificios en el armazón, pueden ajustarse individualmente.

#### Supporto per ripiani in metallico con dispositivo antiribaltamento

I ripiani sono molto robusti e possono essere posizionati individualmente lungo una serie di fori nella scocca

#### Hyldebærer med væltesikring

Hyldeerne er specielt belastbare og kan placeres individuelt i hulrækken i korpus

#### Back panel with acrylate

The coated 3 mm solid fibre back panel is screwed into the cabinet and is additionally sealed at the sides with acrylate for optimum noise absorption.

#### Traseras

El panel trasero revestido de fibra dura de 3 mm se atornilla al cuerpo y adicionalmente se insonoriza lateralmente con acrilato para un aislamiento acústico estupendo.

#### Schienali

Il pannello posteriore in HDF con spessore 3 mm è laccato ed è fissato alla scocca con viti e poi sigillato ai lati con acrilato in modo da garantire un ottimale isolamento acustico

#### Bagvæg med acrylat

Den coatede HDF/MDF-plade 3 mm skrues sammen med korpus og er desuden tætnet i siden med acrylat for at opnå en optimal støjdemping.



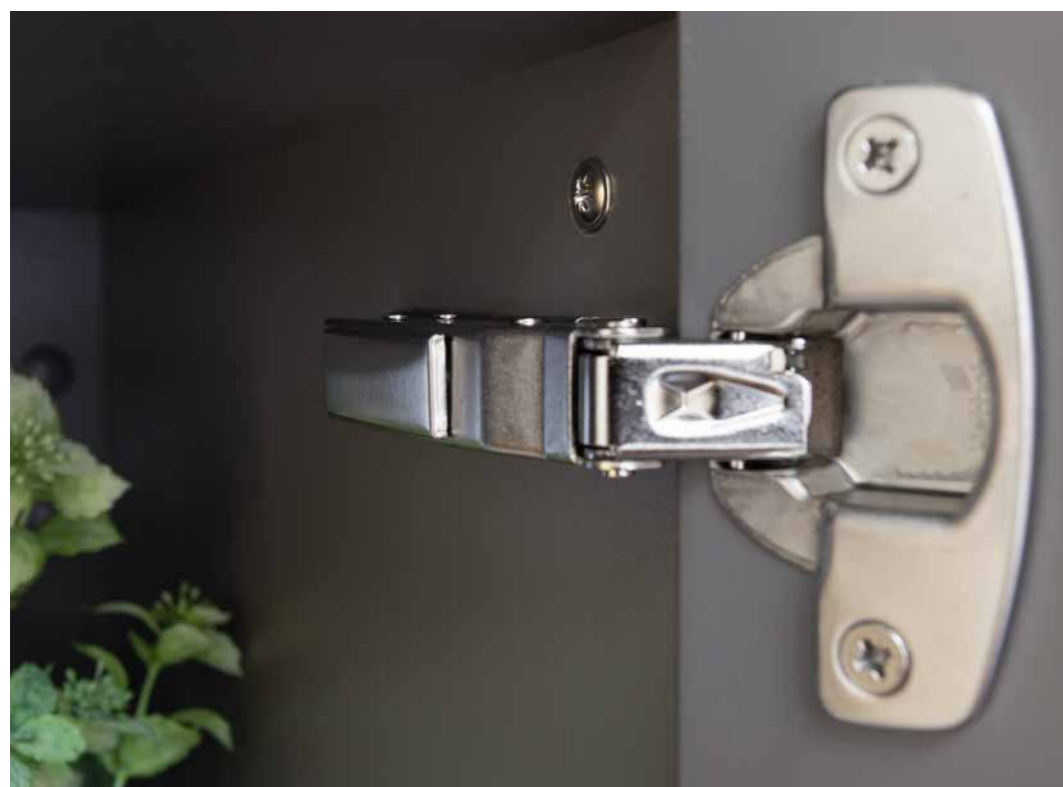

#### Hinge with integrated damping

Installation and disassembling is quick and easy and requires no tools. The hinge can be adjusted in three dimensions.

#### Bisagra con amortiguación integrada

Los muebles se pueden montar y desmontar de forma rápida y sencilla sin herramientas. La bisagra se puede ajustar en tres dimensiones.

#### Cerniera con ammortizzatore integrato

Il meccanismo consente il montaggio e lo smontaggio in modo facile e veloce e senza attrezzi. La cerniera è regolabile in tre direzioni.

#### Hængsel med integreret dæmpning

På- eller afmontering foregår hurtigt og nemt uden brug af værktøj. Hængslet kan justeres tredimensionelt.



#### Profiled railing

At product range ARThandleless, the bottom shelf has a cross-bonded moulding for opening the hanging cupboard.

#### Encolada sobre el perfil de regleta

Para abrir los armarios altos de la serie sin tiradores (ART), la parte delantero del armario cuenta con un listón de perfil encolado.

#### Gola fissata alla scocca

Per l'apertura dei pensili ARTgola il fondo è dotato di un profilo fissato sul bordo frontale.

#### Pålimet profilliste

Bunden forsynes med en pålimet profilliste til at åbne overskabe-  
ne med grebsløsART.



#### Covering wall unit suspension

The cupboard bracket is located out of sight behind back wall of the hanging cupboard and can be adjusted in three dimensions. Covering caps inside the cupboard cover the adjustment screws.

#### Colgador de muebles altos

Los dispositivos de suspensión de los armarios se encuentran escondidos tras la pared posterior del armario alto y se pueden ajustar en tres dimensiones. Las tapas de cubierta en el interior del armario ocultan los tornillos de ajuste.

#### Fissaggio dei pensili nascosto

La sospensione è invisibile, nascosta dietro lo schienale del pensile ed è regolabile in tre direzioni. Le viti di regolazione sono coperte da tappini all'interno del pensile.

#### Skjult skabsophæng

Skabsophænget befinder sig skjult bag overskabets bagvæg og kan justeres tredimensionelt. Blændpropper indvendigt i skabet skjuler justerskruerne.



### ART handleless – Light profile for channel handle

ART handleless means that cabinet panels are milled ready for assembly and the grooved strips are available in stainless steel coloured brushed, lava grey mate, matt white, matt polar white, crystal white, taupe matt, matt graphite or matt black. The end of the strips can be optionally designed with front finishing frames.

### ART sin tirador – Perfil de gola de iluminación

En el acabado „ART sin tirador“, los laterales del cuerpo están fresados listos para su montaje. Las molduras están disponibles en los colores acero inoxidable, saten mate, blanco cristal, lava gris opaco, blanco mate, blanco polar mate, satén, blanco cristal, grafito mate y negro mate. En la terminación de la línea hay la posibilidad de planificar los costados con terminación frontal.

### ARTgola – Profilo luminoso per la gola

Nella cucina con la gola i lati della scocca vengono fresati per essere predisposti per l'installazione dei profili della gola, disponibile in color acciaio inox, grigio lava opaco, bianco opaco, grafito opaco, nero opaco, bianco polare opaco, bianco cristallo opaco e satin opaco. Lateralmente è possibile inserire fianchi di chiusura con gola riportata.

### GrebsløsART – Belysningsprofil med kelleste

Ved grebsløsART bliver korpussiderne fræsset monteringsklar ud, og kellesterne kan leveres i farverne børstet stål, hvid mat, krystal hvid, sort mat, satin mat, grafit mat, lavagrå og polarhvid. Korpusafslutningen kan leveres med vanger på fronten.

Finishes | Acabados | Esecuzioni | Udførelse

**305**

Matt white  
Blanco mate  
Bianco opaco  
Hvid mat

**377**

Matt crystal white  
Blanco cristalino mate  
Cristallo bianco opaco  
Krystal Hvid mat

**376**

Matt graphite  
Grafito mate  
Grafito opaco  
Grafit mat

**352**

Matt polar white  
Blanco polar mate  
Bianco polare opaco  
Polarhvid mat

**363**

Matt taupe  
Saten mate  
Satin opaco  
Satin mat

**355**

Matt black  
Negro mate  
Nero opaco  
Sort mat



**359**

Matt lava grey  
Lava gris opaco  
Grigio lava mat  
Lavagrå mat

**320**

Stainless steel coloured brushed  
Colores acero inoxidable  
Color acciaio inox.  
Rustfritstål farvet

# PULL-OUTS BASE UNITS



## Inner values - special pull-outs

Kitchen 3.0 has strong inner values. The interior colour in fine titanium, combined with a modern powder coating process, results in an excellent depth effect with an extraordinary appearance. The pull-outs consist of a fine, visually attractive 8 mm double-walled steel frame - SLD (Slim Line Drawer).

Closed shelves with a stable metal band running around offer a high level of protection. The high-quality SLD system can also be optionally ordered with smoked glass sides. This attractive package is rounded off by a reliable soft pull-in as well as a useful 3D adjustment device. Beautiful & practical at the same time.

## Valores internos - Extractos especiales

El hecho de que la cocina 3.0 tiene valores internos muy fuertes, rápidamente se hace evidente a primera vista. El acabado interior del titanio noble, en combinación con un moderno proceso de recubrimiento en polvo epoxi, da como resultado un excelente efecto de profundidad con un aspecto excepcional. Las gavetas consisten en un marco de acero de doble pared fino y visualmente hermoso de 8 mm – SLD (Slim Line Drawer).

Los estantes cerrados con correas metálicas resistentes y envolventes, por ejemplo, para alimentos, ofrecen una alta función de protección. El sistema SLD de alta calidad también se puede pedir opcionalmente con paredes de vidrio ahumado. Este atractivo paquete se completa con un seguro mecanismo de cierre suave y un útil dispositivo de ajuste 3D. Agradable y práctico.

## Valori interiori: gli speciali cassetti e cestoni

Che la nostra cucina 3.0 posseda forti valori interiori diventa chiaro a prima vista. Gli interni nel prezioso color titanio di eccezionale profondità, risultato di moderno processo di verniciatura a polvere, hanno un'estetica a dir poco straordinaria. Le sponde dei cassetti e cestoni sono in acciaio a doppia parete con uno spessore totale di appena 8 mm: questo è il sistema SLD (Slim Line Drawer).

I ripiani racchiusi da solide e continue sponde in metallo sono in grado di garantire al contenuto, come ad es. gli alimenti, un elevato grado di protezione. La qualità superiore del sistema SLD è disponibile anche con le sponde in vetro fumé come optional. Completa questo attraente pacchetto l'affidabile meccanismo di chiusura ammortizzata e da un utile sistema di regolazione 3D. Bello e pratico.

## Indre værdier – særlige højdepunkter

At Küche 3.0 har stærke indre værdier, bliver klart ved første øjekast. Den indvendige farve i ædel titan i kombination med en moderne pulverlakeringsproces skaber en fremragende dybdeeffekt med et ekstraordinært udseende. Udtrækkene består af en fin, visuelt smuk 8 mm dobbeltvægget stålramme – SLD (Slim Line Drawer).

Lukkede bakker med omgivende, stabile metalbånd til f.eks. sarte fødevarer. SLD-systemet i høj kvalitet kan også bestilles med røgfarvede glasvægge. Denne attraktive pakke afrundes med en pålidelig blød lukkemekanisme og en nyttig 3D-justeringsenhed. Pænt og praktisk.





### It can be that easy - clever drawer systems

Base units with internal drawers are always useful and make life in the kitchen particularly pleasant. Even better, when these drawers are perfectly equipped. Exactly the way you like it when cooking. With integrated sorting systems, non-slip mats and protective elements. Everything has its place and is always ready to hand. To make things even faster, a so-called „follower” makes it easy to carry the drawer along inside the cabinet pull-outs.

If you like it particularly flexible, just take the MOVE system. Here, individual real wood boxes provide complete freedom in sorting. This is how top-class drawer systems work.

### Así de fácil puede ser - sistemas de cajones bien pensados

Los armarios bajos con cajones interiores son siempre útiles y hacen que la vida en la cocina sea particularmente agradable. Aún mejor si estos cajones vienen con el mejor equipamiento. Como te gusta hacer, cuando cocinas. Con sistemas de clasificación integrados, esterillas antideslizantes y elementos protectores. Así que todo tiene su lugar y siempre está a mano.

Para hacerlo aún más rápido, un llamado „pitón de arrastre” hace que sea fácil llevar el cajón dentro del extractor del armario. Hacia la felicidad.

Si te gusta que sea particularmente flexible, simplemente toma el sistema MOVE. Aquí, la caja de madera auténtica individuales traen total libertad en la clasificación. Así es como funcionan los sistemas de cajones de primera clase.



### Così facile ma anche semplice: l'ingegnoso sistema di cassetti e cestoni

Le basi con cassetti e cestoni interni sono sempre utili e rendono la vita in cucina particolarmente piacevole. Ancora meglio quando questi cassetti sono perfettamente equipaggiati. Proprio come piace a voi quando cucinate, con sistemi di organizzazione interna integrati, tappetini antiscivolo ed elementi di protezione. Così ogni cosa è al suo posto e sempre a portata di mano.

Per rendere le cose ancora più veloci, il trascinatore rende facile l'apertura del cassetto all'interno del cestone. Aperto, chiuso, soddisfatto.

Se il sistema vi piace particolarmente flessibile, allora scegliete MOVE. Gli speciali contenitori in legno massello offrono la massima libertà nell'organizzare gli interni. È così che funzionano i sistemi di alta qualità.



### Så let kan enkelt være – gennemtænkte skuffesystemer

Bundskabe med indvendige skuffer er altid nyttige og gør livet i køkkenet ekstra behageligt. Endnu bedre er det, når disse skuffer er perfekt udstyret. Ligesom du kan lide det, når du laver mad. Med integrerede sorteringsystemer, skridsikre måtter og beskyttelselementer. På den måde har alt har sin plads og er altid ved hånden. For at gøre tingene endnu hurtigere gør en såkaldt „medtager” skuffen nem at køre ind og ud inden i skabets udtræk. Rendyrket køkkennydelse.

Hvis det skal være særlig fleksibelt, kan du blot vælge MOVE-systemet. Individuelle bokse i ægte træ giver fuld frihed til sortering. Sådan fungerer førsteklases skuffesystemer.

# INTERIOR ORGANISATION SYSTEM

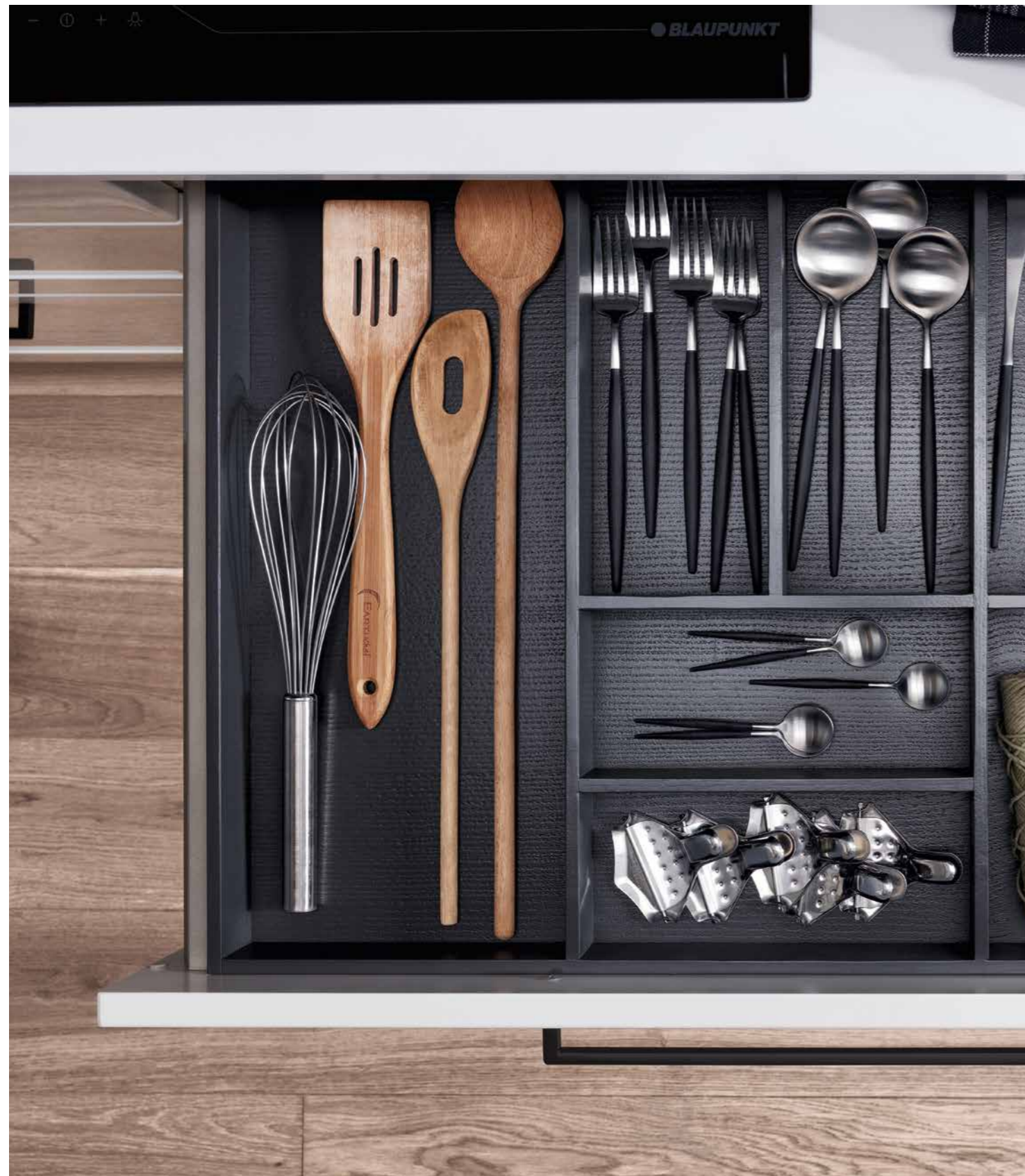

## Interior organisation system

Whether base units with solid wood inside organisation system and cutlery trays or integrated, additional drawers – innovative storage space concepts simplify your work and alleviate organisation.

## Organización interior

Ya sean las gavetas de madera maciza con organización interior, o los portacubiertos, o los cajones adicionales integrados. Los innovadores conceptos de espacio de almacenaje facilitan el trabajo y consiguen el orden.

## L'organizzazione degli interni

Che i cassetti siano dotati di organizzatori in legno massello o di inserti per posate e contenitori supplementari integrati, l'organizzazione degli interni semplifica la vita e crea ordine.

## Indretning

Uanset om fuldudtræk er med indretning af massivt træ og bestikindsatse eller integrerede ekstra sokkelskuffer – innovative opbevaringskoncepter gør arbejdet nemmere og skaber hurtigt orden og overblik.





Interior organisation system **MOVE**

Whether fully extractable sections with inner fittings of heavy wood and cutlery trays or integrated additional pull-outs – innovative storage concepts make work easier and achieve tidiness quickly and simply.

Organización interior **MOVE**

Tanto los cajones de extensión total con organización interior de madera maciza y cuberteros como los cajones adicionalmente integrados son conceptos de almacenaje innovadores que facilitan el trabajo y logran el orden rápida y sencillamente.

Sistema di organizzazione interna **MOVE**

Che i cassetti siano dotati di organizzatori in legno massello o di inserti per posate e contenitori supplementari integrati, gli innovativi sistemi per l'organizzazione degli interni facilitano il lavoro ed aiutano a mettere tutto in ordine in modo facile e veloce.

Skuffeindretning **MOVE**

Skuffeindretningssystemet MOVE af massivt træ giver mange anvendelsesmuligheder takket være de variable elementer – fire rum i tre højder og to forskellige grundflader. Bestikindsats, folieafroller, knivholdere og udligningselementer runder konceptet af, og en antiskridmåtte sørger for, at tingene bliver liggende på deres plads.

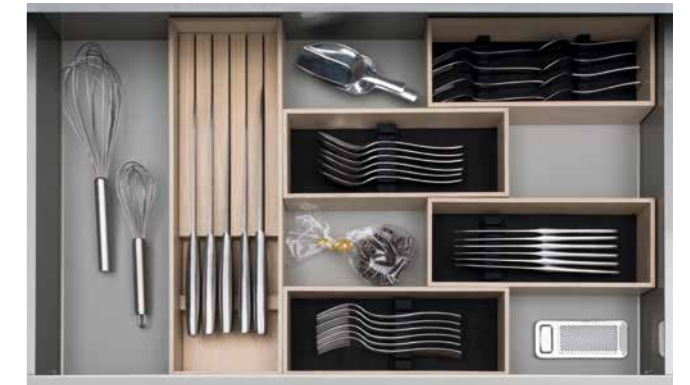

Interior organisation system for pull-outs **MOVE**

Organización interior para gavetas **MOVE**

Sistema di organizzazione interno per cestoni **MOVE**

Indretning **MOVE** til udtræk

Interior organisation system **MOVE**

Organización interior **MOVE**

Sistema di organizzazione interno **MOVE**

Indretning **MOVE** til skuffer



Interior organisation system **MOVE** for tall unit for provisions

Open boxes can also section off the shelves of the high larder cabinets.

Organización interior **MOVE** para armario de almacenaje

Con las cajas abiertas, los estantes de los armarios columnas para provisiones pueden dividirse adicionalmente.

Sistema di organizzazione interno **MOVE** per colonna dispensa

Con i cassettini aperti i ripiani delle colonne dispensa possono essere ulteriormente suddivisi ed organizzati.

Højskab til forråd med fuldudtræk og SoftClose

Her kan boksen fra skuffeindretning MOVE også integreres.

Interior organisation **MOVE** with recess equipment Linero MosaiQ

The universal shelf of the corner construction unit can also be fitted with an open box.

Organización interior **MOVE** con equipamiento de entrepaño Linero MosaiQ

El anaquel universal de la barra puede equiparse además con una caja abierta.

Sistema di organizzazione interno **MOVE** con accessorio per nicchia Linero MosaiQ

Anche il ripiano universale per la barra porta utensili può essere allestito con cassettini aperti.

Nicheindretning Linero MosaiQ

# EXTRAS

Extras  
Optional  
Options



Corner base unit LeMans

Heavy duty and totally robust: corner units with swing-out shelves make full use of every nook and cranny.

Armario bajo de rincón LeMans

Sumamente resistentes y de gran solidez: Armarios de rincón con estantes giratorios garantizan espacio hasta en el último rincón.

Base angolare LeMans

Grande portata unita a grande solidità: le basi angolari con piani girevoli estraibili sfruttano lo spazio anche nell'angolo più remoto.

Svingudtræk LeMans

med metalræling



### Waste systems

There are different systems available. Be it hanging in a pull-out frame or upright in the pull-out. The choice of container size can be made depending on requirements.

### Sistema de basura

Se encuentran disponibles diferentes sistemas. O bien suspendido en el marco de módulo extraíble o en posición vertical en el módulo extraíble. Según se precise, se puede elegir entre diferentes volúmenes contenedores.

### Sistema di raccolta differenziata

Una buona progettazione si riconosce anche nei molti accessori intelligenti che aiutano ad affrontare il lavoro di tutti i giorni in cucina.

### Affaldssystemer

Der kan vælges mellem forskellige systemer. Enten hængende i udtræksrammen eller stående i udtrækket. Alt efter behov kan der vælges mellem forskellige beholderstørrelser.



### Tall units

Adjustable hanging shelves with solid bases and closed metal strips.

### Armarios columnas

Los bandejas colgables regulables con fondo fijo y banda de metal cerrada.

### Colonne

Ripiani da appendere, con fondo rigido e ringhierina in metallo chiusa.

### Højskabe til forråd

Indstillelige hylder med fast bund og lukket metalkant.





### Lightning

You can choose from a variety of lighting systems for planning.

### Iluminación

Durante la planificación tiene a disposición diferentes sistemas de luz.

### Illuminazione

Per la progettazione sono disponibili diversi sistemi di illuminazione.

### Belysning

Der er forskellige typer belysningsystemer tilgængelige.

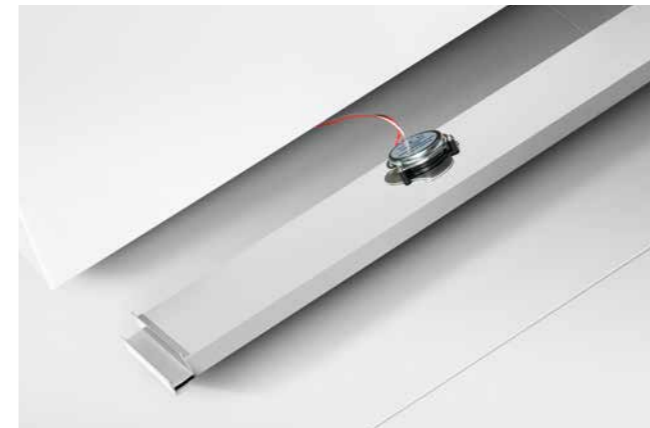
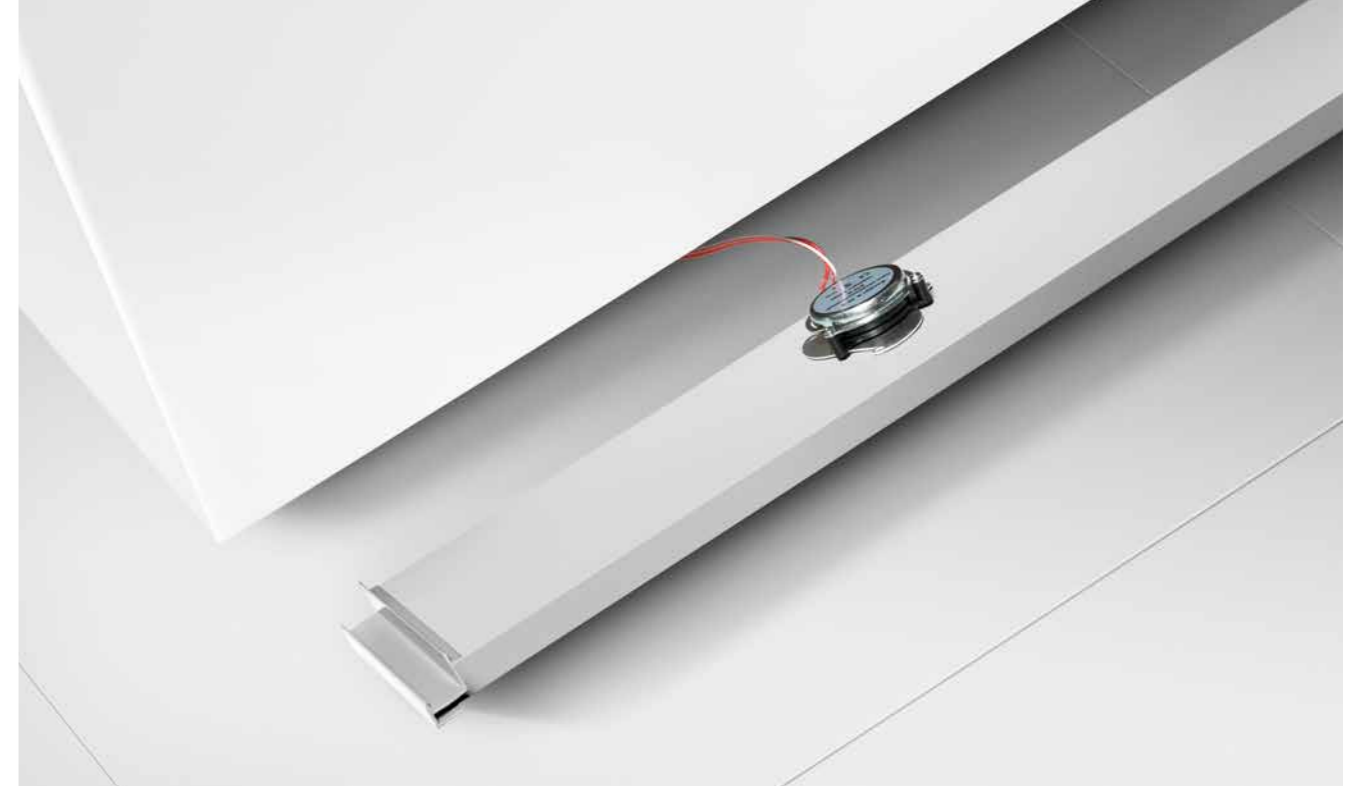
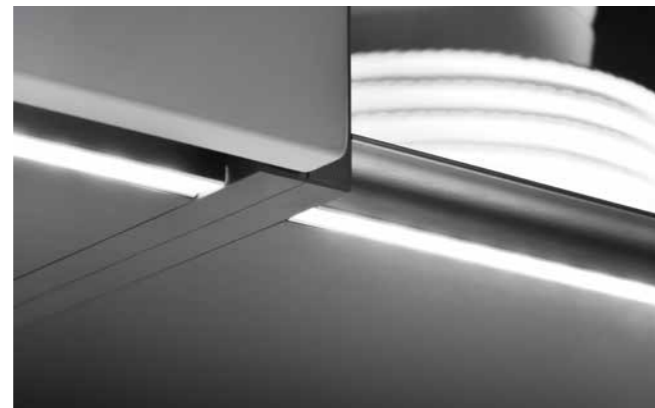

### Sound system

Assembly recommendations behind plinth panel; Operated via Bluetooth connection, e.g. using a smartphone or tablet

### Sistema de sonido

Recomendación de montaje detrás del zócalo; el manejo se realiza a través de conexión Bluetooth por ejemplo, con el teléfono o la tabla

### Sound System

Montaggio consigliato dietro la fascia zoccolo. Comandi attivabili tramite connessione Bluetooth, per es. da smartphone/tablet

### Soundsystem

Anbefalet montering bag sokkelafblændingen. Betjening sker via bluetooth-forbindelse f.eks. via smartphone eller tablet

Qi charger for inductive load  
 Qi cargador (Qi Charger) para carga inductiva  
 Qi Charger per carico a induzione  
 Charger til induktiv opladning

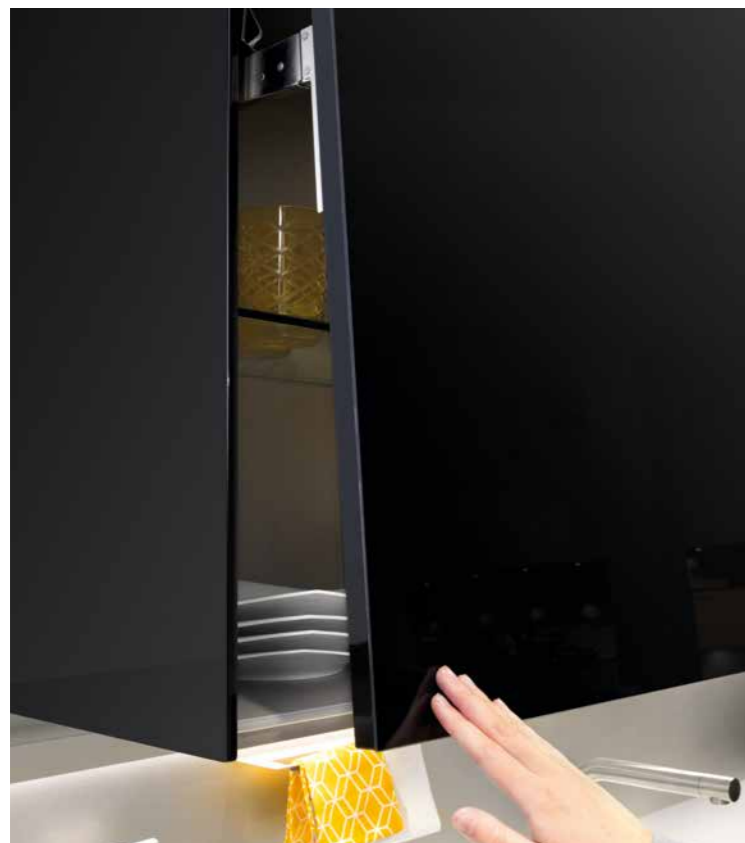

### Electronics

Flap door and swivel door can be connected additionally to the power supply and thus offer electronic support when opening.

### Electrónica

La puerta abatible y la puerta basculante pueden electrificarse adicionalmente, por lo que ofrecen una ayuda de apertura electrónica.

### Elettronica

L'anta basculante e a libro possono essere dotati di meccanismo elettronico che offre il vantaggio di un'apertura comoda e facilitata.

### Elektronik

Klap og svinglåde kan desuden elektrificeres og bliver dermed til en elektronisk åbningshjælp.



### Sensomatic | Tipmatic Softclose

There are two systems behind the drawer: Sensomatic – the electronic opening aid or Tipmatic Softclose – the mechanical opening aid installed in the factory

### Sensomatic | Tipmatic Softclose

Tras la gaveta hay dos sistemas disponibles: Sensomatic, el soporte de apertura electrónico, o Tipmatic Softclose, el soporte de apertura mecánica montada por parte de la fábrica.

### Sensomatic | Tipmatic Softclose

Dietro ai cassetti possono essere inseriti due sistemi di apertura assistita: Sensomatic, il facilitatore elettronico di apertura, o Tipmatic Softclose, il dispositivo meccanico di apertura montato direttamente in fabbrica.

### Sensomatic | Tipmatic SoftClose

Der findes to systemer til skufferne: Sensomatic – den elektroniske åbningshjælp eller Tipmatic SoftClose – den mekaniske åbningshjælp, der er monteret fra fabrikken.

## Front overview

The variety of designs is second to none. You can freely choose and combine finishing materials. A large selection of designs is also available for 'handlelessART'.

## Frentes – Visión de conjunto

La diversidad de muebles satisface todos los deseos. Puede elegir y combinar libremente los diferentes materiales. También se suministra una gran diversidad de los programas para el sistema ART sin asas.

## Elenco modelli

La varietà di modelli disponibili non lascia alcun desiderio insoddisfatto. Potrete scegliere e combinare a piacimento i differenti materiali. Anche per la cucina con la gola sono disponibili diversi modelli.

## Fronter – oversigt

De forskellige modeller opfylder alle ønsker. Du kan frit vælge mellem og kombinere materialelever-sionerne. Mange af programmerne er også tilgængelige til handle-lessART.

### AV 1080 PG0

Laminate/fine structured | Material sintético/textura fina | Laminato/struttura fine | Laminatstruktur

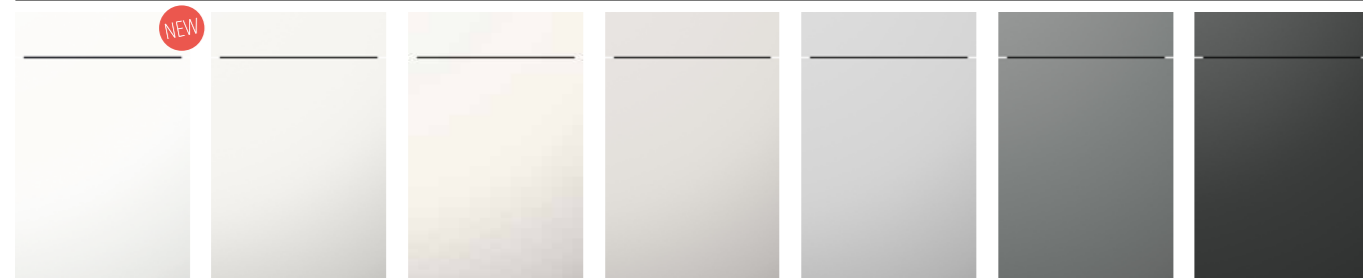

Crystal white (ART) Blanco cristalino (ART) Bianco cristallo (ART) Krystal Hvid (ART)	Polar white (ART) Blanco polar (ART) Bianco polare (ART) Polar Hvid (ART)	White (ART) Blanco (ART) Bianco (ART) Hvid (ART)	Taupe (ART) Satén (ART) Satin (ART) Satin (ART)	Light grey (ART) Gris luminoso (ART) Grigio chiaro (ART) Lysgrå (ART)	Lava grey (ART) Lava gris (ART) Grigio lava (ART) Lavagrå (ART)	Graphite (ART) Grafito (ART) Grafite (ART) Graphite (ART)
--	--	---	--	--	--	--

### AV 1070 PG1

Laminate structured/Putty concrete | Material sintético/Hormigón enfoscado estructurado | Laminato strutturata/Calcestr. spatolato | Laminatstruktur/Beton



Opal grey (ART) Gris opalino (ART) Grigio opale (ART) Opalgrå (ART)	Pearl grey (ART) Gris perla (ART) Grigio perla (ART) Perlegrå (ART)	Graphite (ART) Grafito (ART) Grafite (ART) Beton Grafit (ART)
--	--	--

### AV 1097 PG1

Laminate/synchronous pore | Material sintético/superficie poro sincrónico | Laminato sincroporo | Laminat/ Porestruktur



Sand vintage oak (ART) Roble envejecido arena (ART) Rovere antico sabbia (ART) Sand Vintage Eg (ART)	Natural vintage oak (ART) Roble envejecido natural (ART) Rovere antico natura (ART) Natural Vintage Eg (ART)	Cognac vintage oak (ART) Roble envejecido coñac (ART) Rovere antico cognac (ART) Cognac Vintage Eg (ART)
---	---	---

### AV 1098 PG2

Laminate/synchronous pore | Material sintético/superficie poro sincrónico | Laminato sincroporo/materico | Laminat/ Porestruktur



Okobo coffee brown (ART) Okobo café marrón (ART) Okobo caffè (ART) Okobo Brun (ART)	Okobo black grey (ART) Okobo negro gris (ART) Okobo grigio-nero (ART) Okobo Sortgrå (ART)
--	--

### AV 2045 PG2

Satin lacquer | Laca mate satinada | Laccato opaco | Lakeret mat

PerfectSense®



Carrara white (ART) Carrara blanco (ART) Carrara bianco (ART) Carrara Hvid (ART)	Marble grey (ART) Mármol gris (ART) Marmo grigio (ART) Marmor Grå (ART)	Marble dark (ART) Mármol oscuro (ART) Marmo scuro (ART) Mørk Marmor (ART)
---	--	--

### AV 2065 PG2

Laminate/matt | Material sintético/mate | Laminato/opaco | Laminat mat

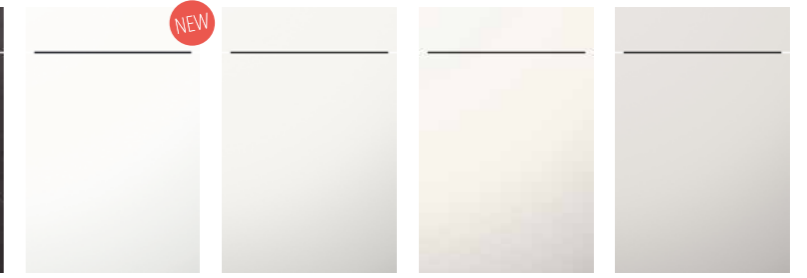

Crystal white (ART) Blanco cristalino (ART) Bianco cristallo (ART) Krystal Hvid (ART)	Polar white (ART) Blanco polar (ART) Bianco polare (ART) Polar Hvid (ART)	White (ART) Blanco (ART) Bianco (ART) Hvid (ART)	Taupe (ART) Satén (ART) Satin (ART) Satin (ART)
--	--	---	--

### AV 2130 PG2

High gloss lacquer | Lacado alto brillo | Laccato lucido brillante | Højglanslakeret

PerfectSense®

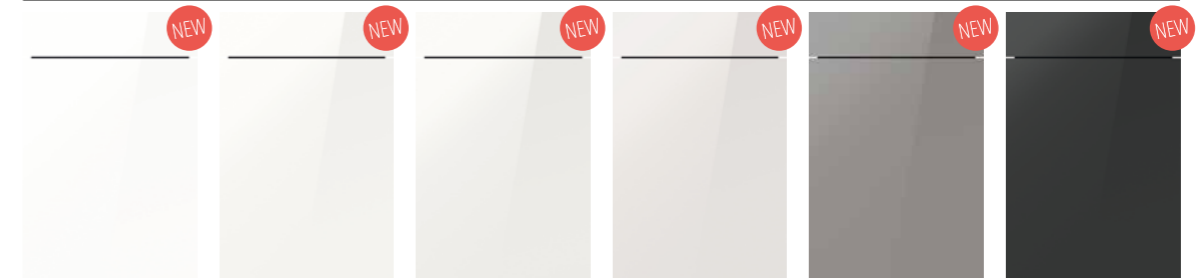

Crystal white (ART) Blanco cristalino (ART) Bianco cristallo (ART) Krystal Hvid (ART)	Polar white (ART) Blanco polar (ART) Bianco polare (ART) Polar Hvid (ART)	White (ART) Blanco (ART) Bianco (ART) Hvid (ART)	Taupe (ART) Satén (ART) Satin (ART) Satin (ART)	Pearl grey (ART) Gris perla (ART) Grigio perla (ART) Perlegrå (ART)	Graphite (ART) Grafito (ART) Grafite (ART) Graphite (ART)
--	--	---	--	--	--

### AV 2135 PG2

Satin lacquer | Laca mate satinada | Laccato opaco | Maling laminat mat

PerfectSense®

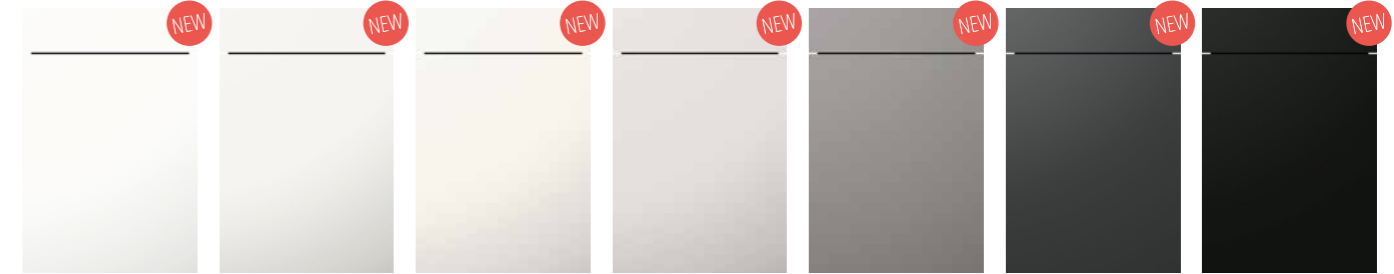

Crystal white (ART) Blanco cristalino (ART) Bianco cristallo (ART) Krystal Hvid (ART)	Polar white (ART) Blanco polar (ART) Bianco polare (ART) Polar Hvid (ART)	White (ART) Blanco (ART) Bianco (ART) Hvid (ART)	Taupe (ART) Satén (ART) Satin (ART) Satin (ART)	Pearl grey (ART) Gris perla (ART) Grigio perla (ART) Perlegrå (ART)	Graphite (ART) Grafito (ART) Grafite (ART) Graphite (ART)	Black (ART) Negro (ART) Nero (ART) Sort (ART)
--	--	---	--	--	--	--

### AV 3030 PG2

Laminated matt | Polilaminado mate | Foglio polimerico opaco | Laminat mat

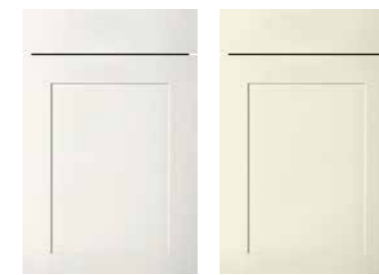

White Blanco Bianco Hvid	Magnolia Magnolia Magnolia Magnolia
-----------------------------------	--

### AV 4030 PG3

High gloss lacquer | Lacado alto brillo | Laccato lucido brillante | Højglanslakeret



Crystal white (ART) Blanco cristalino (ART) Bianco cristallo (ART) Krystal Hvid (ART)	Polar white (ART) Blanco polar (ART) Bianco polare (ART) Polar Hvid (ART)	White (ART) Blanco (ART) Bianco (ART) Hvid (ART)	Taupe (ART) Satén (ART) Satin (ART) Satin (ART)	Pearl grey (ART) Gris perla (ART) Grigio perla (ART) Perlegrå (ART)
--	--	---	--	--

**AV 4030 PG3**



Graphite (ART)  
Grafito (ART)  
Grafite (ART)  
Grafit (ART)

Velvet blue (ART)  
Azul seda (ART)  
Blu velluto (ART)  
Fløjsblå (ART)

Black (ART)  
Negro (ART)  
Nero (ART)  
Sort (ART)

**AV 6000 PG3**

Satin lacquer | Laca mate satinada | Laccato opaco | Lakeret mat

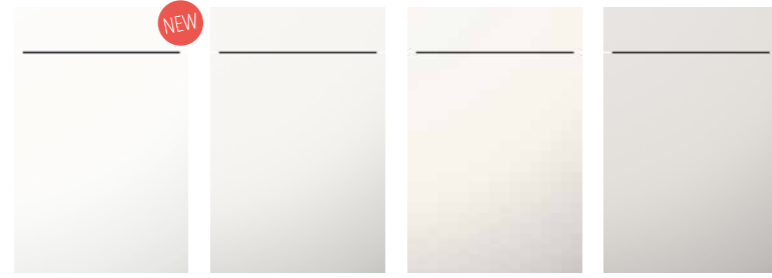

Crystal white (ART)  
Blanco cristalino (ART)  
Bianco cristallo (ART)  
Krystal Hvid (ART)

Polar white (ART)  
Blanco polar (ART)  
Bianco polare (ART)  
Polar Hvid (ART)

White (ART)  
Blanco (ART)  
Bianco (ART)  
Hvid (ART)

Taupe (ART)  
Satén (ART)  
Satin (ART)  
Satin (ART)

**AV 6000 PG3**



Light grey (ART)  
Gris luminoso (ART)  
Grigio chiaro (ART)  
Lysgrå (ART)

Pearl grey (ART)  
Gris perla (ART)  
Grigio perla (ART)  
Perlegrå (ART)

Lava grey (ART)  
Lava gris (ART)  
Grigio lava (ART)  
Lavagrå (ART)

Graphite (ART)  
Grafito (ART)  
Grafite (ART)  
Grafit (ART)

Velvet blue (ART)  
Azul seda (ART)  
Blu velluto (ART)  
Fløjsblå (ART)

Black (ART)  
Negro (ART)  
Nero (ART)  
Sort (ART)

**AV 5007 PG4**

Satin lacquer | Laca mate satinada | Laccato opaco | Lakeret mat



Crystal white  
Blanco cristalino  
Bianco cristallo  
Krystal Hvid

Polar white  
Blanco polar  
Bianco polare  
Polarhvid

White  
Blanco  
Bianco  
Hvid

Taupe  
Satén  
Satin

Light grey  
Gris luminoso  
Grigio chiaro  
Lysgrå

Pearl grey  
Gris perla  
Grigio perla  
Perlegrå

Lava grey  
Lava gris  
Grigio lava  
Lavagrå

**AV 5007 PG4**



Graphite  
Grafito  
Grafite  
Grafit

Velvet blue  
Azul seda  
Blu velluto  
Fløjsblå

Black  
Negro  
Nero  
Sort

**AV 5030 PG4** High gloss lacquer | Lacado alto brillo | Laccato lucido brillante | Højglanslakeret



White  
Blanco  
Bianco  
Hvid

**AV 5040 PG4** High gloss lacquer | Lacado alto brillo | Laccato lucido brillante | Højglanslakeret



White  
Blanco  
Bianco  
Hvid

**AV 5035 PG4**

Satin lacquer | Laca mate satinada | Laccato opaco | Lakeret mat



Crystal white  
Blanco cristalino  
Bianco cristallo  
Krystal Hvid

Polar white  
Blanco polar  
Bianco polare  
Polar Hvid

White  
Blanco  
Bianco  
Hvid

Taupe  
Satén  
Satin  
Satin

Light grey  
Gris luminoso  
Grigio chiaro  
Lysgrå

Pearl grey  
Gris perla  
Grigio perla  
Perlegrå

Lava grey  
Lava gris  
Grigio lava  
Lavagrå

**AV 5035 PG4**



Graphite  
Grafito  
Grafite  
Grafit

Velvet blue  
Azul seda  
Blu velluto  
Fløjsblå

Black  
Negro  
Nero  
Sort

**AV 6035 PG5** Ash lacquer real wood frame veneered center panel | fresno lacado marco macizo plafón chapado | frassino laccato telaio massello fodrina impiallacciata | Lakeret rammelåge i ask



Crystal white  
Blanco cristalino  
Bianco cristallo  
Krystal Hvid

White  
Blanco  
Bianco  
Hvid

Magnolia  
Magnolia  
Magnolia  
Magnolia

Taupe  
Satén  
Satin  
Satin

**AV 6035 PG5**



Agate blue  
Ágata azul  
Agata blu  
Agatblå

Velvet blue  
Azul seda  
Blu velluto  
Fløjsblå

Light grey  
Gris luminoso  
Grigio chiaro  
Lysgrå

Pearl grey  
Gris perla  
Grigio perla  
Perlegrå

Lava grey  
Lava gris  
Grigio lava  
Lavagrå

Pastel green  
Verde pastel  
Verde pastello  
Pastelgrøn

Graphite  
Grafito  
Grafite  
Grafit

**AV 6035 PG5**



Black  
Negro  
Nero  
Sort



Crystal white  
Blanco cristalino  
Bianco cristallo  
Krystal Hvid

White  
Blanco  
Bianco  
Hvid



Magnolia  
Magnolia  
Magnolia  
Magnolia

Taupe  
Satén  
Satin  
Satin



Agate blue  
Ágata azul  
Agata blu  
Agatblå

Velvet blue  
Azul seda  
Blu velluto  
Fløjsblå

**AV 6055 PG5** Ash lacquer real wood frame veneered center panel | Fresno lacado marco macizo plafón chapado | Frassino laccato telaio massello fodrina impiallacciata | Lakeret rammelåge i ask

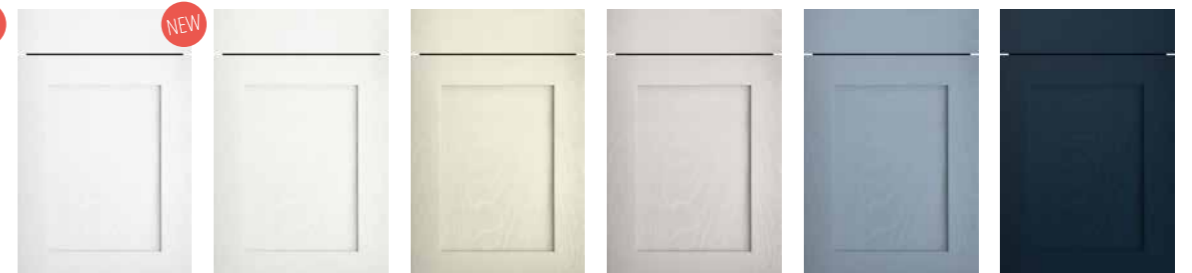

Black  
Negro  
Nero  
Sort

Crystal white  
Blanco cristalino  
Bianco cristallo  
Krystal Hvid

White  
Blanco  
Bianco  
Hvid

Magnolia  
Magnolia  
Magnolia  
Magnolia

Taupe  
Satén  
Satin  
Satin

Agate blue  
Ágata azul  
Agata blu  
Agatblå

Velvet blue  
Azul seda  
Blu velluto  
Fløjsblå

**AV 6055 PG5**

RAL

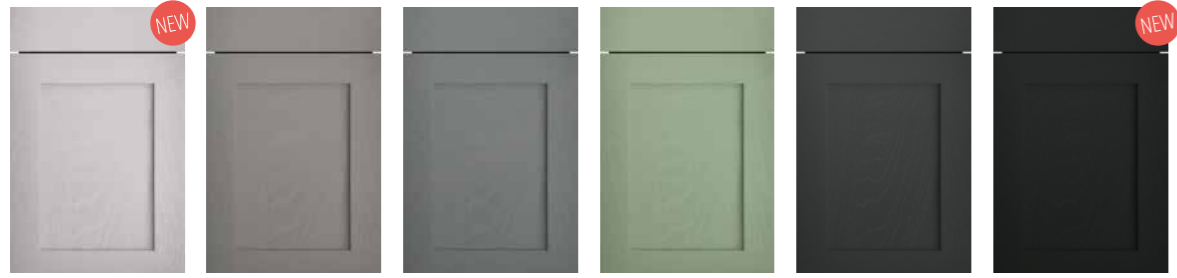

Light grey	Pearl grey	Lava grey	Pastel green	Graphite	Black
Grís luminoso	Gris perla	Lava gris	Verde pastel	Grafito	Negro
Grigio chiaro	Grigio perla	Grigio lava	Verde pastello	Grafite	Nero
Lysgrå	Perlegrå	Lavagrå	Pastelgrøn	Grafit	Sort

**AV 6021 PG6** Real wood veneer rough-cut finish | Madera genuina chapada aserrado carrasposo | Vero legno impiallacciato tranché | Fineret ægte træ

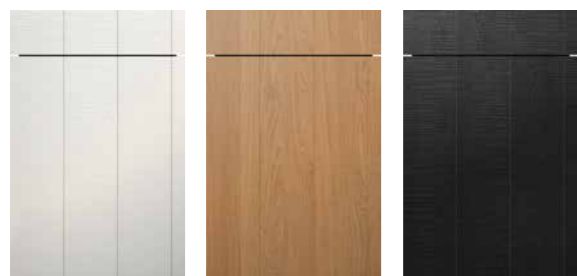

White oak (ART)	Light oak (ART)	Black oak (ART)
Roble blanco (ART)	Roble luminoso (ART)	Roble negro (ART)
Rovere bianco (ART)	Rovere chiara (ART)	Rovere nero (ART)
Hvid Eg (ART)	Lys Eg (ART)	Sort Eg (ART)

**AV 5090 PG7** Design glass | Cristal de diseño | Vetro design | Design glas



Crystal white (ART)	Polar white (ART)	White (ART)	Taupe (ART)
Blanco cristalino (ART)	Blanco polar (ART)	Blanco (ART)	Satén (ART)
Bianco cristallo (ART)	Bianco polare (ART)	Bianco (ART)	Satin (ART)
Krystal Hvid (ART)	Polar Hvid (ART)	Hvid (ART)	Satin (ART)

**AV 5090 PG7**

**AV 5095 PG7** Design glass mate | Cristal de diseño opaco | Vetro design opaco | Design glas mat



Gold bronze metallic (ART)	Black (ART)	Crystal white (ART)	Polar white (ART)	White (ART)	Taupe (ART)	Black (ART)
Oro bronce metálico (ART)	Negro (ART)	Blanco cristalino (ART)	Blanco polar (ART)	Blanco (ART)	Satén (ART)	Negro (ART)
Oro bronzo metallico (ART)	Nero (ART)	Bianco cristallo (ART)	Bianco polare (ART)	Bianco (ART)	Satin (ART)	Nero (ART)
Guld Bronze Metallic (ART)	Sort (ART)	Krystal Hvid (ART)	Polar Hvid (ART)	Hvid (ART)	Satin (ART)	Sort (ART)

**AV 6080 PG8**

Real wood veneer brushed | Madera genuina chapada cepillado | Vero legno impiallacciato spazzolato | Fineret ægte træ

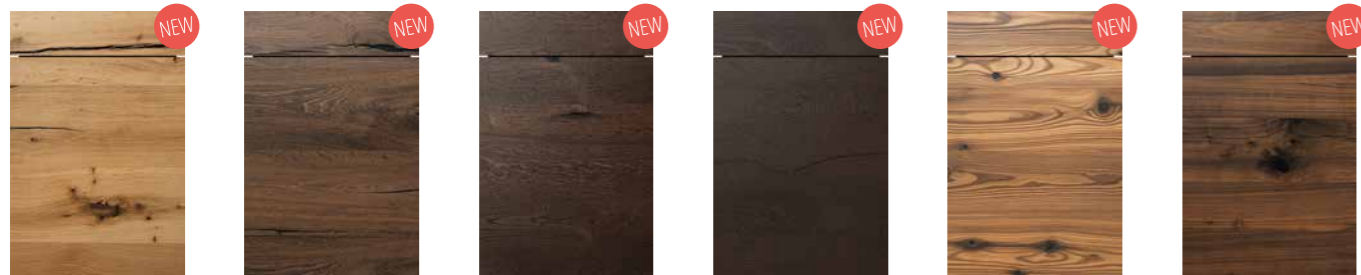

Natural wild oak (ART)	Nougat wild oak (ART)	Sherry vintage oak (ART)	Mocha vintage oak (ART)	Larch (ART)	Walnut (ART)
Roble silvestre natural (ART)	Roble silvestre nougat (ART)	Roble envejecido jerez (ART)	Roble envejecido moca (ART)	Lárice (ART)	Nogal (ART)
Rovere selvatico naturale (ART)	Rovere selvatico nougat (ART)	Chêne antique sherry (ART)	Rovere antico moca (ART)	Larice (ART)	Noce (ART)
Naturlig Vild Eg (ART)	Nougat Vild Eg (ART)	Sherry Vintage Eg (ART)	Mokka Vintage Eg (ART)	Lærk (ART)	Valnød (ART)

**AV 6082 PG8**

Real wood veneer brushed | Madera genuina chapada cepillado | Vero legno impiallacciato spazzolato | Fineret ægte træ



Natural wild oak (ART)	Nougat wild oak (ART)	Sherry vintage oak (ART)	Mocha vintage oak (ART)	Larch (ART)	Walnut (ART)
Roble silvestre natural (ART)	Roble silvestre nougat (ART)	Roble envejecido jerez (ART)	Roble envejecido moca (ART)	Lárice (ART)	Notenhout (ART)
Rovere selvatico naturale (ART)	Rovere selvatico nougat (ART)	Chêne antique sherry (ART)	Rovere antico moca (ART)	Larice (ART)	Noyer (ART)
Naturlig Vild eg (ART)	Nougat Vild eg (ART)	Sherry Vintage Eg (ART)	Mokka Vintage Eg (ART)	Lærk (ART)	Valnød (ART)

**AV 8000 PG8**

Ceramic | Cerámica | Ceramica | Keramik



Calacatta (ART)	Concrete (ART)	Iron Grey (ART)	Basalt Black (ART)
Calacatta (ART)	Hormigón (ART)	Iron Grey (ART)	Basalto Black (ART)
Calacatta (ART)	Calcestruzzo (ART)	Iron Grey (ART)	Basalto Black (ART)
Calacatta (ART)	Beton (ART)	Iron Grey (ART)	Basalte Black (ART)

**AV 6084 PG9** Real wood veneer embossed | Madera genuina chapada en relieve | Vero legno impiallacciato goffrato | Fineret ægte træ

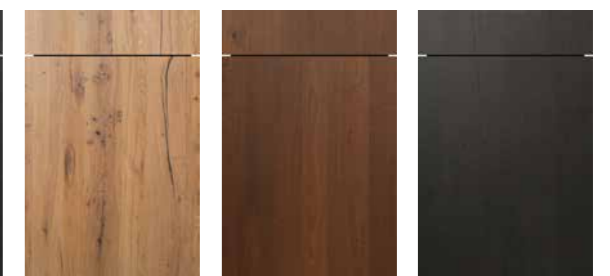

Reclaimed wood (ART)	Smoked oak (ART)	Volcano oak (ART)
Madera vieja (ART)	Roble ahumado (ART)	Roble volcán (ART)
Legno antico (ART)	Rovere bruciato (ART)	Rovere vulcano (ART)
Drivtømmer (ART)	Røget Eg (ART)	Vulkan Eg (ART)

**AV 7030 PG9** Stone veneered | Piedra chapado | Struttura pietra | Sten finér



Silver Star (ART)	Black Star (ART)
Silver Star (ART)	Black Star (ART)
Silver Star (ART)	Black Star (ART)
Silver Star (ART)	Black Star (ART)

**AV 7070 PG9** Metallic lacquer smoothed | Pintura metálica lijada | Laccatura metallizzata levigato | Malet metallak



Industrial steel (ART)	Copper (ART)
Acero industrial (ART)	Cobre (ART)
Acciaio industrial (ART)	Rame (ART)
Industrieltål (ART)	Kobber (ART)

**AV 5007 PG4**

**AV 5035 PG4**

**AV 6000 PG3**

**AV 6035 PG5**

**AV 6055 PG5**





**18** Arizona pine effect  
Pino arizona repro.  
Effetto pino Arizona  
Arizona fyrtræ effekt

**08** Silk grey oak effect  
Roble gris seda repro.  
Effetto rovere grigio seta  
Silkegrå effekt

**25** Oak sand effect  
Roble arena repro.  
Effetto rovere sabbia  
Sand Eg effect

**69** Natural butcherblock effect  
Tajadero natural repro.  
Effetto butcherblock list. nat.  
Naturlig Skærebræt effekt

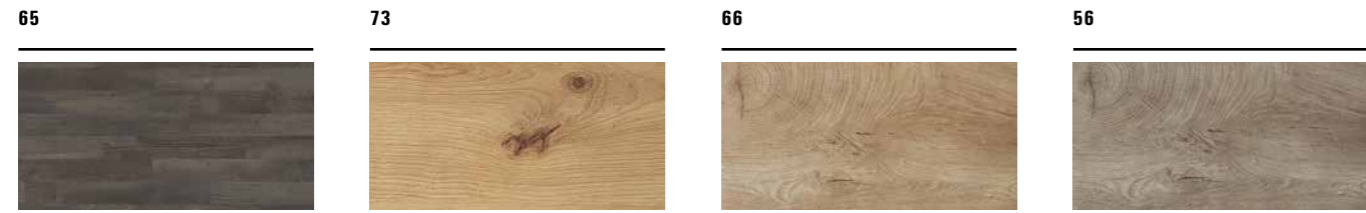

**65** Rustic butcherblock effect  
Tajadero rústico repro.  
Effetto butcherblock list. rust.  
Rustik Skærebræt effekt

**73** Summer oak effect  
Roble de verano repro.  
Effetto farnia  
Sommer Eg effekt

**66** Natural oak grain-cut timber effect  
Roble duramen natural repro.  
Effetto rovere durame natura  
Natur Eg Endetræ effekt

**56** Grey oak grain-cut timber effect  
Roble duramen gris repro.  
Effetto rovere durame grigio  
Grå Eg Endetræ effekt



**129** Natural vintage oak effect  
Roble envejecido natural repro.  
Effetto rovere antico natura  
Natural Vintage Eg effekt

**123** Cognac vintage oak effect  
Roble envejecido coñac repro.  
Effetto rovere antico cognac  
Cognac Vintage Eg effekt

**128** Grey oak effect  
Roble gris repro.  
Effetto rovere grigio  
Grå Eg effekt

**12** Ontario oak effect  
Roble ontario repro.  
Effetto rovere ontario  
Ontario Eg effekt

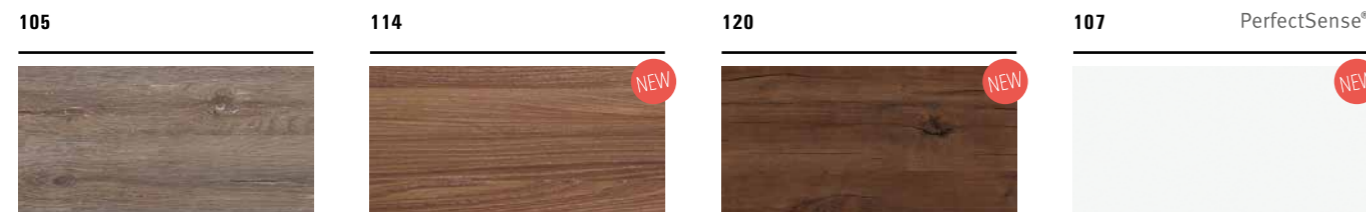

**105** Vintage oak effect  
Roble vintage repro.  
effetto rovere vintage  
Vintage Eg effekt

**114** Walnut effect  
Nogal repro.  
Noce vintage  
Valnød effekt

**120** Mountain oak effect  
Roble montaña repro.  
Effetto rovere di montagna  
Mountain Eg effekt

**107** PerfectSense®  
Crystal white PerfectSense  
Blanco cristalino PerfectSense  
Bianco cristallo PerfectSense  
Krystal Hvid PerfectSense

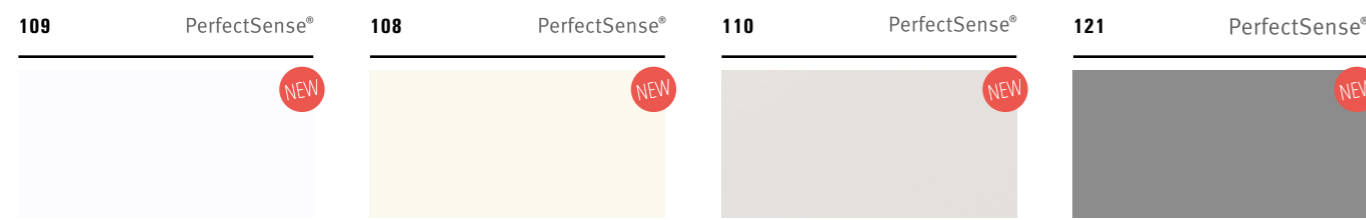

**109** PerfectSense®  
Polar white PerfectSense  
Blanco polar PerfectSense  
Bianco polare PerfectSense  
Polar Hvid PerfectSense

**108** PerfectSense®  
White PerfectSense  
Blanco PerfectSense  
Bianco PerfectSense  
Hvid PerfectSense

**110** PerfectSense®  
Taupe PerfectSense  
Satén PerfectSense  
Satin PerfectSense  
Satin PerfectSense

**121** PerfectSense®  
Pearl grey PerfectSense  
Gris perla PerfectSense  
Grigio perla PerfectSense  
Perlegrå PerfectSense

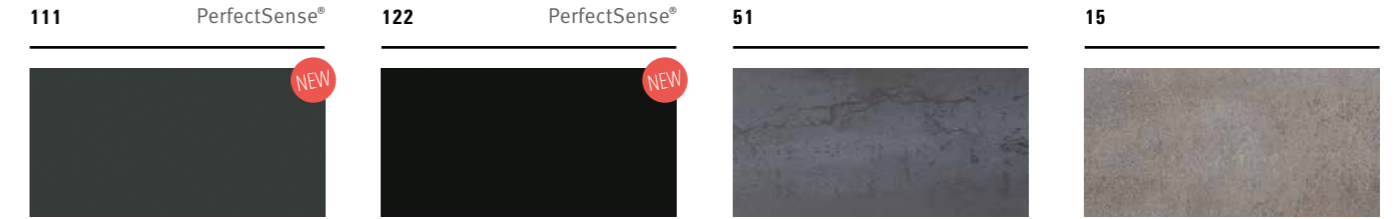

**111** PerfectSense®  
Graphite PerfectSense  
Grafito PerfectSense  
Grafite PerfectSense  
Grafit PerfectSense

**122** PerfectSense®  
Black PerfectSense  
Negro PerfectSense  
Nero PerfectSense  
Sort PerfectSense

**51** Black steel  
Acero negro  
Acciaio nero  
Sort Stål

**15** Oxide  
Óxido  
Ossido  
Oxid



**200** Stainless steel coloured brushed  
Color acero inoxidable cepillado  
Color acciaio inox spazzolato  
Rustfritstål farvet

**106** Niagara  
Niagara  
Niagara  
Niagara

**33** Ventura  
Ventura  
Ventura  
Ventura

**27** Mica slate  
Micacita  
Micascito  
Micaskifer

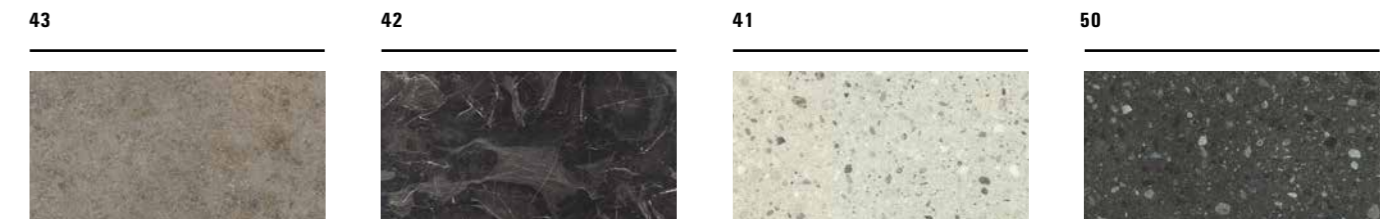

**43** Salento grey beige  
Salento beige gris  
Salento grigio beige  
Salento gråbeige

**42** Imperia brown  
Imperia marrón  
Imperia marrone  
Imperiabrun

**41** Light terrazzo  
Terrazo claro  
Terrazzo chiaro  
Lys Terazzo

**50** Dark terrazzo  
Terrazo oscuro  
Terrazzo scuro  
Mørk Terazzo

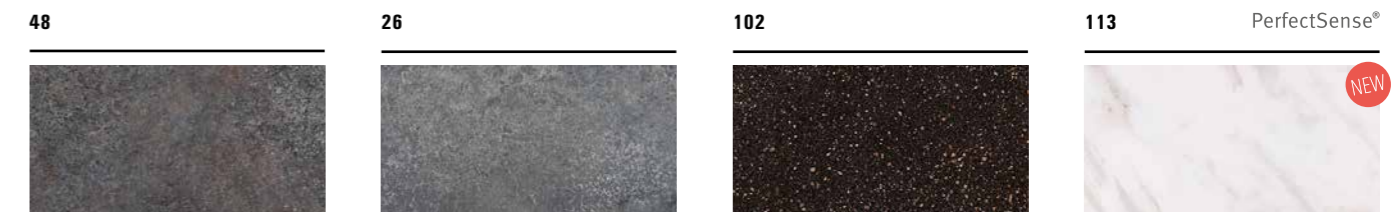

**48** Aurora  
Aurora  
Aurora  
Aurora

**26** Terra  
Tierra  
Terra  
Terra

**102** Nero  
Nero  
Nero  
Nero

**113** PerfectSense®  
Carrara white PerfectSense  
Carrara blanco PerfectSense  
Carrara bianco PerfectSense  
Carrara Hvid PerfectSense



**112** PerfectSense®  
Marble grey PerfectSense  
Mármol gris PerfectSense  
Marmo grigio PerfectSense  
Marmor Grå PerfectSense

**119** PerfectSense®  
Marble dark PerfectSense  
Mármol oscuro PerfectSense  
Marmo scuro PerfectSense  
Mørk Marmor PerfectSense

**116** Luna dark  
Luna oscuro  
Luna scura  
Luna mørk

**24** Marble black  
Mármol negro  
Marmo nero  
Sort marmor

95



Putty concrete opal grey  
Hormigón enfoscado gris opalino  
Calcestruzzo spatolato grigio opale  
Beton opalgrå

39



Putty concrete pearl grey  
Hormigón enfoscado gris perla  
Calcestruzzo spatolato grigio perla  
Beton perlegrå

101



Putty concrete graphite  
Hormigón enfoscado grafito  
Calcestruzzo spatolato grafite  
Beton grafit

### Handles

There are many handle systems, apart from knobs and grips, which are supplied to match cabinet widths.

### Tiradores

Además de botones y tiradores, hay muchos sistemas de agarre, que se suministran conforme a las anchuras del armario.

### Maniglie

Sono disponibili diverse tipologie di pomelli e maniglie, tutte abbinate alla larghezza degli armadi.

### Greb

Ud over knopper og greb findes der mange grebssystemer, der leveres passende til skabsbredderne.

105



343



308



440



302



312



344



111



378



311



446



304



318



359



112



340



424



524



306



319



371



117



409



433



301



307



332



372



NEW

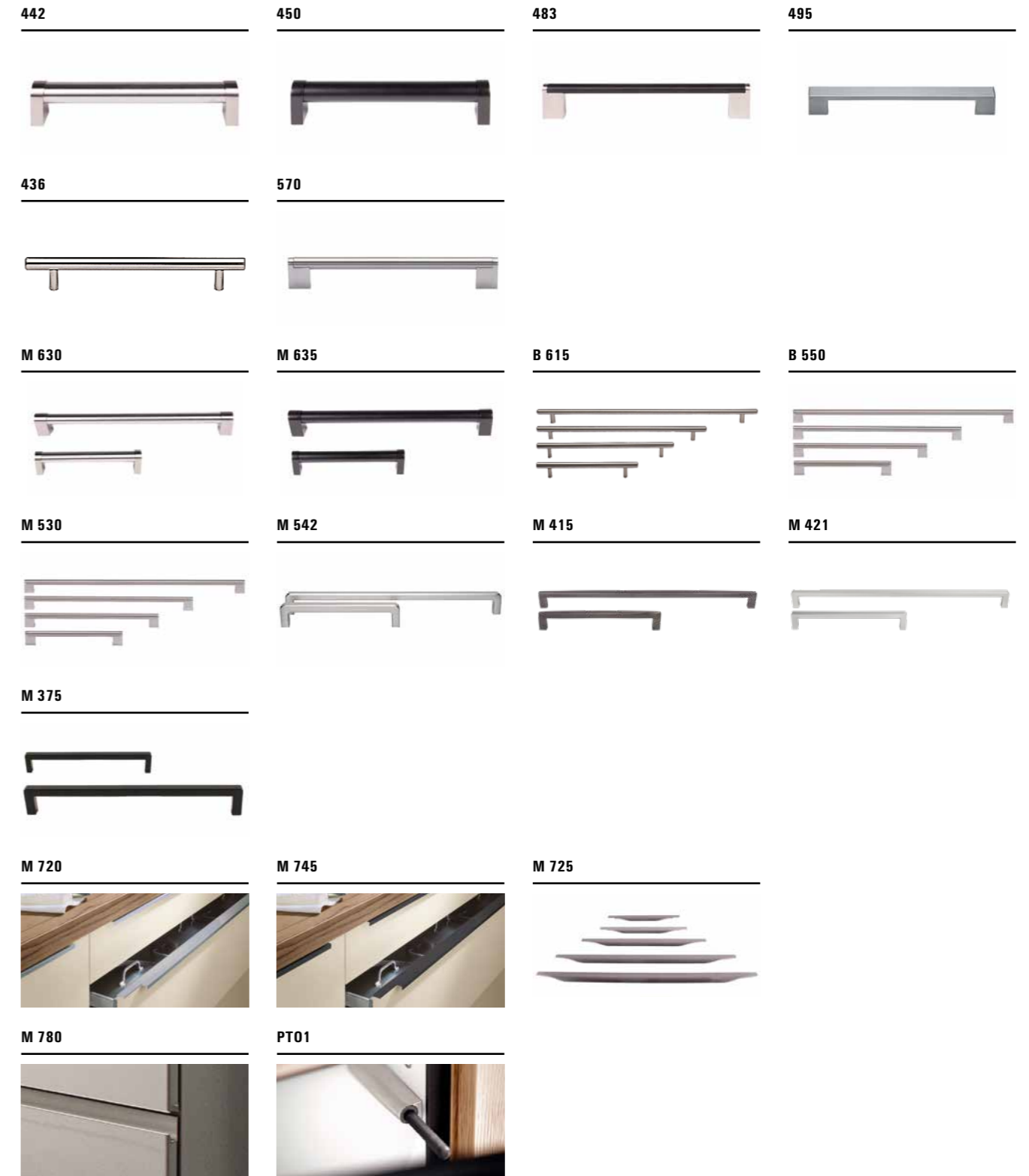





### With PURemission we are setting new exceptional standards!

Advanced medicine, healthy food and a balanced environment: all of these factors make a major contribution to a healthy way of life. The drawbacks: stress and certain materials can lead to intolerances and pressure. Consumers are more sensitive than ever to topics such as formaldehyde.

Wood naturally contains formaldehyde. This can leak into the air in small quantities. We acknowledge the fact that we are currently one of the largest kitchen manufacturers, providing wood-based materials with the lowest emissions!

Through careful selection of timber materials and suppliers, since September 2017 we were able to change complete stock and process wood-based materials, where the formaldehyde content has been drastically reduced. The European standard is largely undercut and the high American standards are fulfilled by 100 percent.

PURemission stands for clean indoor air and quality at the highest level.

### ¡Con PURemission establecemos nuevos estándares!

El avance en la medicina, una alimentación sana y también un entorno saludable contribuyen en gran medida a un modo de vida sano. Por otra parte: el estilo de vida, el estrés y determinados materiales pueden provocar intolerancias y un alto grado de estrés. Los consumidores se muestran más sensibles que nunca ante temas como el formaldehído.

La madera natural contiene formaldehído, el cual también se expulsa al exterior en bajas cantidades.

Con nuestras cocinas tenemos en cuenta estos hechos: ¡actualmente somos uno de los mayores fabricantes de muebles de cocina con todos los materiales de madera con las emisiones más bajas!

Gracias a una esmerada selección de los materiales de madera y de nuestros proveedores, en septiembre de 2017 se logró cambiar todo el inventario y procesar exclusivamente materiales de madera cuyo porcentaje de formaldehído fue reducido drásticamente. La norma europea queda en su mayor parte por debajo y los elevados estándares americanos se cumplen al 100 por cien.

PURemission representa un aire ambiental limpio y una calidad al máximo nivel.

### Con PURemission abbiamo creato nuovi standard!

I progressi nella medicina, un'alimentazione sana e un ambiente salutare danno un grande contributo per migliorare lo stile di vita. Gli aspetti negativi: lo stress e determinati materiali possono causare intolleranze e pressioni eccessive. I consumatori oggi sono sensibili più che mai su determinati argomenti, come ad esempio la formaldeide.

Il legno per sua natura può contenere formaldeide e la rilascia in piccole quantità anche verso l'esterno. Noi teniamo conto di questo aspetto ed attualmente tra i produttori di cucine componibili più grandi siamo quelli che impiegano materiali derivati del legno con le emissioni più basse!

Grazie ad una selezione accurata e consapevole delle materie prime e dei nostri fornitori, è stato possibile convertire l'intero stock già a settembre 2017 e lavorare esclusivamente materiali di derivazione del legno con un contenuto di formaldeide drasticamente ridotto. Le emissioni dei nostri prodotti sono sensibilmente al di sotto dello standard europeo e soddisfano al 100 % anche gli elevati standard americani.

PURemission è il simbolo per un'aria pulita in casa e per una qualità ai massimi livelli.

### Vi sætter nye standarder – med PURemission!

Medicinske fremskridt, en alsidig kost samt et passende miljø bidrager i stort omfang til en bedre levevis. Bagsiden af medaljen: Livsstil, stress og visse stoffer kan medføre intolerance og stressbelastning. Forbrugere er mere end nogensinde tidligere overfølsomme over for emner som f.eks. formaldehyd.

Træ indeholder fra naturens hånd formaldehyd. Formaldehyd slipper også ud i det fri i små mængder.

Det tager vi højde for: Aktuelt er vi en af de største køkkenproducenter, der benytter træmateriale med den laveste emission!

Gennem et omhyggeligt og ansvarsbevidst valg af træmaterialer og leverandører er det lykkedes for os, allerede tilbage i september 2017, at omstille hele lagerbeholdningen, så vi kun forarbejder træ, hvor indholdet af formaldehyd er nedbragt drastisk. For det meste ligger vi under den europæiske standard, og de skrappe amerikanske standarder overholdes 100 procent.

PURemission står for ren indendørs luft og kvalitet på højeste niveau.



### PUResist – waterproof edges

What happens with the edges of our kitchen cabinets when they are exposed to a lot of water steam? Thanks to PUResist our innovative and high-quality bonding technology, the simple answer is: nothing!

PUResist guarantees the highest quality characteristics: the edges of our kitchen furniture are water-repellent, resistant and have an excellent appearance due to the invisible joint. And the glue of those edges? Formaldehyde and solvent-free!

PUResist offers

- Protection against the ingress of moisture, e.g. at the cooking and sink areas
- Strong adhesion between the wooden materials and the edges
- An excellent look and feel because of invisible joints
- Best quality characteristics for all edges

PUResist and PURemission: all-round protection for your kitchen and for you.

### Mostramos los cantos, con PUResist

¿Qué ocurre en realidad con los cantos de los armarios de cocina cuando se exponen al vapor? Gracias a nuestra innovadora tecnología de encolado de gran calidad PUResist la respuesta es sencilla: ¡nada!

PUResist garantiza las características máximas de calidad: los cantos de nuestros muebles de cocina repelen el vapor, son resistentes y, gracias a las juntas de visibilidad cero, presentan un aspecto excelente. ¿Y el encolado? ¡Libre de formaldehído y disolventes!

PUResist ofrece

- protección contra la penetración de la humedad, por ejemplo en la zona de cocción y del fregadero
- una fuerte adhesión entre el material de madera y los cantos
- excelente óptica gracias a la llamada «junta cero visible»
- extraordinarias características de calidad en todos los cantos

PUResist y PURemission: protección integral para nuestras cocinas y para usted.

### PUResist: la sicurezza di una bordatura perfetta

Cosa accade ai bordi dei mobili della cucina quando vengono esposti al vapore acqueo? Grazie alla nostra innovativa e valida tecnologia di bordatura PUResist, la risposta è semplice: assolutamente niente!

PUResist garantisce i massimi requisiti di qualità: i bordi dei nostri mobili sono idrorepellenti, resistenti ed esteticamente insuperabili grazie alla giunzione invisibile. E la colla? Priva di formaldeide e di solventi!

PUResist garantisce

- protezione dalla penetrazione di umidità, come nella zona cottura e lavaggio
- una forte aderenza tra materiale di legno e bordo
- un'estetica straordinaria grazie alla giunzione invisibile
- caratteristiche di qualità superiore su tutti i bordi

PUResist e PURemission: protezione completa per le nostre cucine e per voi.

### Vi viser kant – med PUResist

Hvad sker der egentlig med kanterne på køkkenskabe, når de udsættes for vanddamp? Takket være vores innovative førsteklases limningsteknologi PUResist er svaret simpelthen: ingenting!

PUResist sikrer fremragende kvalitetsegenskaber: Kanterne på vores køkkenmøbler er vandafvisende, modstandsdygtige og har en fremragende optik på grund af den usynlige fuge. Og limningen? Fri for formaldehyd og opløsningsmidler!

PUResist betyder

- beskyttelse mod fugtindtrængen, f.eks. i madlavnings- og vaskområdet
- stærkere binding mellem træet og kanten
- fremragende optik på grund af den usynlige fuge
- bedste kvalitetsegenskaber ved alle kanter

PUResist og PURemission: Sikkerhed hele vejen igennem for vores køkkener og for dig.

# WE ARE CERTIFIED

SOMOS EXCELENTES | SIAMO CERTIFICATI | VI LIGGER I SPIDSEN



First manufacturer of climate-neutral kitchen furniture with positive CO<sub>2</sub> balance according to the comprehensive CFP study. | Primer fabricante de muebles de cocina clima-neutral con un balance de CO<sub>2</sub> positivo según el estudio de la PPC. | Primo produttore di cucine componibili a impatto neutrale sul clima con bilancio CO<sub>2</sub> positivo come da studio CFP. | Første producent af klimaneutrale køkkenelementer med en positiv CO<sub>2</sub>-balance ifølge CFP-undersøgelser.



Nach den Richtlinien für den Klimaschutz der Deutschen Gütegemeinschaft Möbel • According to the Guidelines for Climate Protection of the DGM • [www.dgm-klimapakt.de](http://www.dgm-klimapakt.de)



Nach den Richtlinien für den Klimaschutz der Deutschen Gütegemeinschaft Möbel • According to the Guidelines for Climate Protection of the DGM • [www.klimaneutral-dgm.de](http://www.klimaneutral-dgm.de)



Awards for our climate-neutral production  
Premios por nuestra producción neutral en el clima  
Cetrificazioni della nostra produzione a impatto neutrale sul clima  
Priser for vores klimaneutrale produktion



Geographical Indication of Origin "Furniture Made in Germany"  
Signo de Garantía de Origen Geográfico "Muebles hechos en Alemania"  
Indicazione di origine certificata "Mobili Made in Germany"  
Geografisk oprindelsesgarantimærke "Möbel Made in Germany"



Awards for healthy living furniture  
Premios para Muebles Saludables  
Certificazione dei mobili per l'abitare sano  
Priser for sunde møbler



We promote sustainable forest management  
Promovemos la gestión forestal sostenible  
Noi incoraggiamo la gestione sostenibile delle foreste  
Vi fremmer bæredygtig skovforvaltning



Awards for our formaldehyde-reduced furniture  
Premios por nuestro muebles reducidos de formaldehído  
Certificazione per i nostri mobili con minima emissione di formaldeide  
Priser for vores formaldehydreducerede møbler



Certified energy management system | Certificado de gestión energética |  
Sistema di gestione energetica certificato | Certificeret energistyringssystem



Certified environmental management system | Gestión ambiental certificado |  
Sistema di gestione ambientale certificato | Certificeret miljøstyringssystem



Tested safety of all kitchen furniture | Seguridad probada de la gama de muebles de cocina |  
Sicurezza della gamma di prodotto testata | Gennemprøvet sikkerhed inden for køkkenelementprogrammet



We reserve the right to alter sizes and specification of goods without notice and are not liable for printing errors. This catalogue supercedes previous catalogues.

Reservado el derecho de modificaciones en el programa, material, modelo y medidas. Todos los ejemplos de instalación se entienden sin compromiso. Nos reservamos el derecho de notificar las erratas de imprenta. El presente catálogo invalida a todos los demás publicados hasta ahora.

Con riserva di modifiche riguardanti programma, materiali, esecuzione, dimensioni. Gli esempi di arredamento mostrati non sono impegnativi. Con riserva di correzione di eventuali errori di stampa. La pubblicazione del presente catalogo annulla tutti i cataloghi precedenti.

Forbehold for ændringer i programmet, materialet, udførelsen og målene. Alle indretningseksempler er uden forbindelse. Forbehold for trykfejl. Med udgivelsen af dette katalog er alle foregående udgaver ugyldige.

online version



Printed in Germany 08/2020  
Art.-Nr. AV-B-21